

# 3/8 Modular Valves

## Type of Modular Valve

Class	Model Numbers	Graphic Symbols	Page	Class	Model Numbers	Graphic Symbols	Page	
Pressure Control Valves	Solenoid Operated Directional Valve (S-)DSG-03-***-50/5090 E-DSG-03-***-D*50/5090 T-DSG-03-***-D24*50/5090 G-DSG-03-***-50/5090		361 378 379 412	Flow Control Valves	Temperature Compensated Throttle and Check Valves (for "A&B-Lines", Metre-out) MSTW-03-X-20		595	
	Relief Valves (for "P-Line") MBP-03-*30		578		Throttle Valves (for "P-Line") MSP-03-30		598	
	Relief Valves (for "A-Line") MBA-03-*30		578		Check and Throttle Valves (for "P-Line") MSCP-03-20		600	
	Relief Valves (for "B-Line") MBB-03-*30		578		Throttle and Check Valves (for "A-Line", Metre-out) MSA-03-X-40		602	
	Relief Valves (for "A&B-Lines") MBW-03-*30		578		Throttle and Check Valves (for "A-Line", Metre-in) MSA-03-Y-40		602	
	Reducing Valves (for "P-Line") MRP-03-*30/3090		581		Throttle and Check Valves (for "B-Line", Metre-out) MSB-03-X-40		602	
	Reducing Valves (for "A-Line") MRA-03-*30/3090		581		Throttle and Check Valves (for "B-Line", Metre-in) MSB-03-Y-40		602	
	Reducing Valves (for "B-Line") MRB-03-*30/3090		581		Throttle and Check Valves (for "A&B-Lines", Metre-out) MSW-03-X-40		602	
	Reducing Valves for Low Pressure Setting (for "P-Line") MRLP-03-10/1090		584		Throttle and Check Valves (for "A&B-Lines", Metre-in) MSW-03-Y-40		602	
	Reducing Valves for Low Pressure Setting (for "A-Line") MRLA-03-10/1090		584		Directional Control Valves	Check Valves (for "P-Line") MCP-03-*10		605
	Reducing Valves for Low Pressure Setting (for "B-Line") MRLB-03-10/1090		584			Check Valves (for "A-Line") MCA-03-*20		605
	Sequence Valves (for "P-Line") MHP-03-*20		588			Check Valves (for "B-Line") MCB-03-*20		605
	Counterbalance Valves (for "A-Line") MHA-03-*20		588			Check Valves (for "T-Line") MCT-03-*10		605
	Counterbalance Valves (for "B-Line") MHB-03-*20		588			Check Valves (for "P&T-Lines") MCPT-03-P*-T*-10		607
Flow Control Valves	Flow Control Valves (for "P-Line") MFP-03-11		591	Anti-Cavitation Valves MAC-03-10			609	
	Flow Control and Check Valves (for "A-Line", Metre-out) MFA-03-X-11		591	Pilot Operated Check Valves (for "A-Line") MPA-03-*20/2001			610	
	Flow Control and Check Valves (for "A-Line", Metre-in) MFA-03-Y-11		591	Pilot Operated Check Valves (for "B-Line") MPB-03-*20/2001			610	
	Flow Control and Check Valves (for "B-Line", Metre-out) MFB-03-X-11		591	Pilot Operated Check Valves (for "A&B-Lines") MPW-03-*20/2001			610	
	Flow Control and Check Valves (for "B-Line", Metre-in) MFB-03-Y-11		591	Modular Plates and Mounting Bolts		End Plates (Blocking Plates) MDC-03-A-10		613
	Flow Control and Check Valves (for "A&B-Lines", Metre-out) MFW-03-X-11		591			End Plates (Bypass Plates) MDC-03-B-10		613
	Flow Control and Check Valves (for "A&B-Lines", Metre-in) MFW-03-Y-11		591			Connecting Plates MDS-03-10/1090		614
	Temperature Compensated Throttle and Check Valves (for "A-Line", Metre-out) MSTA-03-X-20		595			Base Plates MMC-03-T*-21/2180/2190		615
	Temperature Compensated Throttle and Check Valves (for "B-Line", Metre-out) MSTB-03-X-20		595			Bolt Kits MBK-03-*10/1090		618

## Relief Modular Valves

### Specifications

Model Numbers	Max. Operating Pressure MPa (PSI)	Max. Flow L/min (U.S.GPM)
MBP-03-* MBA-03-* MBB-03-* MBW-03-*	31.5 (4570)	70 (18.5)

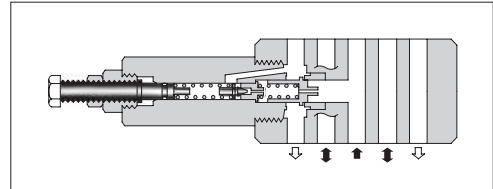

### Model Number Designation

F-	MBA	-03	-B	-30	*
Special Seals	Series Number	Valve Size	Pres. Adj. Range MPa (PSI)	Design Number	Design Standard
<b>F:</b> Special Seals for Phosphate Ester Type Fluids (Omit if not required)	<b>MBP</b> : Relief Valve for P-Line <b>MBA</b> : Relief Valve for A-Line <b>MBB</b> : Relief Valve for B-Line <b>MBW</b> : Relief Valve for A&B-Lines	<b>03</b>	<b>B</b> : *-7 <sup>★1</sup> (*-1020) <b>H</b> : 3.5-31.5 (510-4570)	<b>30</b>	Refer to <sup>★2</sup>

★1. See the "Minimum Adjustment Pressure" of the next page for the item marked \*.

★2. Design Standards: None ..... Japanese Standard "JIS", European Design Standard and N. American Design Standard

### Instructions

- The minimum adjustment pressure equals the value obtained from the minimum adjustment pressure characteristics plus the tank line back pressure of the next page. This back pressure should include the value of the T-line pressure drop characteristics of the valves stacked to the base plate side of the modular valve.
- To make pressure adjustment, loosen the lock nut and turn the pressure adjustment screw clockwise or anti-clockwise. For an increase of pressure, turn the screw clockwise. Be sure to re-tighten the lock nut firmly after making adjustment to the pressure.
- In case of a small flow, the setting pressure may become unstable. To avoid this, refer to the minimum flow characteristic curve of the next page and use the valve within a range as shown with .

Model Numbers	Graphic Symbols	Detailed Graphic Symbols
MBP-03		
MBA-03		
MBB-03		
MBW-03		

## Typical Performance Characteristics

Hydraulic Fluid: Viscosity 35 mm<sup>2</sup>/s (164 SSU), Specific Gravity 0.850

### Nominal Override Characteristics

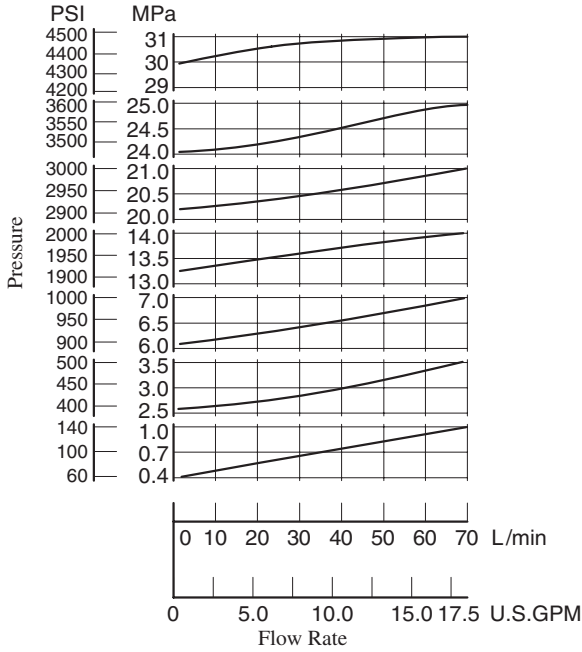

### Min. Adjustment Pressure

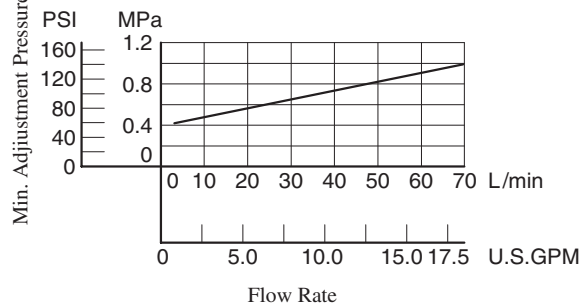

### Min. Flow vs. Adjustment Pressure

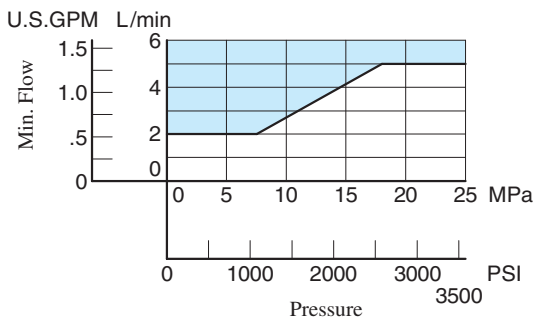

### Pressure Drop

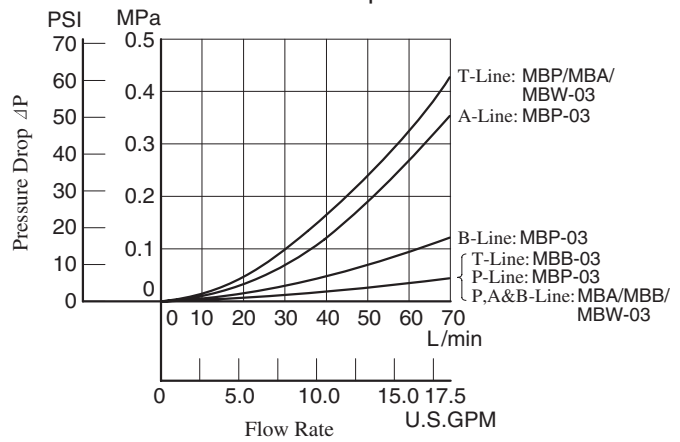

**MBW-03-\*-30**

**DIMENSIONS IN MILLIMETRES (INCHES)**

Approx. Mass..... 3.8 kg (8.4 lbs.)

**MBP-03-\*-30**  
**MBA-03-\*-30**

Approx. Mass..... 3.1 kg (6.8 lbs.)

• For other dimensions, refer to "MBW-03" drawing left.

---

**MBB-03-\*-30**

Approx. Mass..... 3.1 kg (6.8 lbs.)

• For other dimensions, refer to "MBW-03" drawing left.

**■ Spare Parts List**

**MBP-03-\*-30**  
**MBA-03-\*-30**

**MBB-03-\*-30**

**MBW-03-\*-30**

● List of Seals

Item	Name of Parts	Part Numbers	Quantity			
			MBP-03	MBA-03	MBB-03	MBW-03
15	O-Ring	SO-NB-A014	5	5	5	5
16	O-Ring	SO-NA-P6	1	1	1	2
17	O-Ring	SO-NB-P16	1	1	1	2
18	O-Ring	SO-NB-P26	1	1	1	2

Note: When ordering seals, please specify the seal kit number from the table right.

● List of Seal Kits

Valve Model Numbers	Seal kit Numbers
MBP-03	KS-MBP-03-30
MBA-03	
MBB-03	
MBW-03	KS-MBW-03-30

## Reducing Modular Valves

### Specifications

Model Numbers	Max. Operating Pressure MPa(PSI)	Max. Flow L/min (U.S.GPM)
MRP-03-*-30/3090 MRA-03-*-30/3090 MRB-03-*-30/3090	25 (3630)	70 (18.5)★

★ In pressure adjustment range "H", if the pressure in the primary side is set above 20 MPa (2900 PSI) and the pressure in the secondary side is set below 10 MPa (1450 PSI), the maximum flow is limited to 50 L/min (13.2 U.S.GPM).

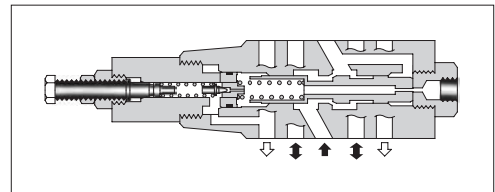

### Model Number Designation

F-	MRP	-03	-B	-30	*
Special Seals	Series Number	Valve Size	Pres. Adj. Range MPa (PSI)	Design Number	Design Standard
<b>F:</b> Special Seals for Phosphate Ester Type Fluids (Omit if not required)	<b>MRP:</b> Reducing Valve for P-Line <b>MRA:</b> Reducing Valve for A-Line <b>MRB:</b> Reducing Valve for B-Line	<b>03</b>	<b>B:</b> 1-7 (145-1020) <b>H:</b> 3.5-24.5 (510-3550)	<b>30</b>	Refer to ★

★ Design Standards: None ..... Japanese Standard "JIS" and European Design Standard  
90 ..... N. American Design Standard

### Instructions

- The minimum adjustment pressure equals the lower limit of either pressure adjustment range (B, H) plus the tank line back pressure of the [next page](#). This back pressure should include the value of the T-line pressure drop characteristics of the valves stacked to the base plate side of the modular valve.
- To make pressure adjustment, loosen the lock nut and turn the pressure adjustment screw clockwise or anti-clockwise. For an increase of pressure, turn the screw clockwise. Be sure to re-tighten the lock nut firmly after making adjustment to the pressure.

Model Numbers	Graphic Symbols	Detailed Graphic Symbols
MRP-03		
MRA-03		
MRB-03		

**Typical Performance Characteristics**

Hydraulic Fluid: Viscosity 35 mm<sup>2</sup>/s (164 SSU), Specific Gravity 0.850

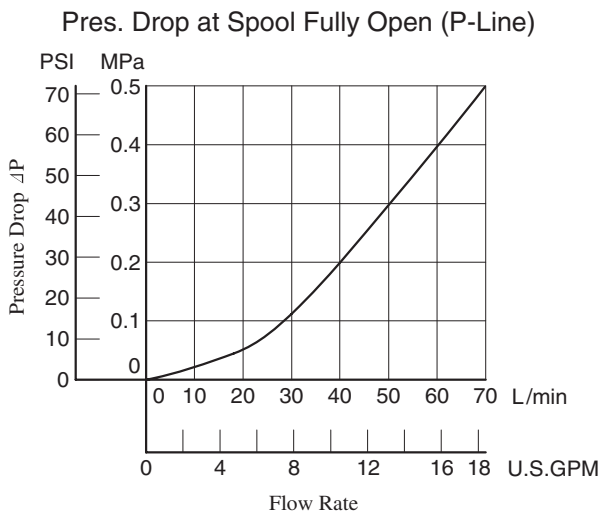
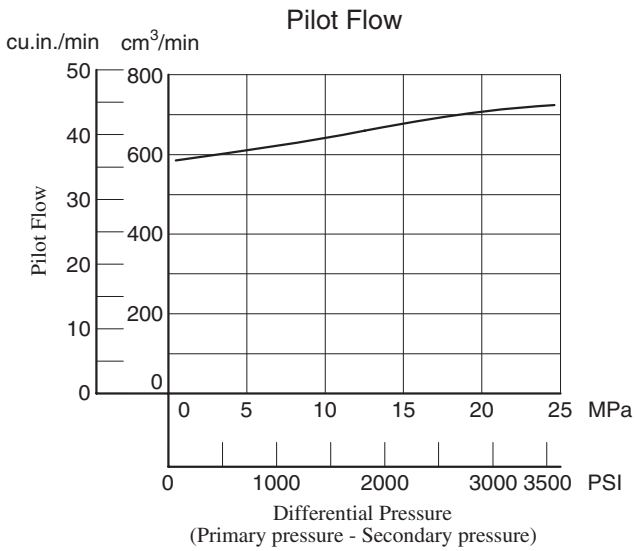
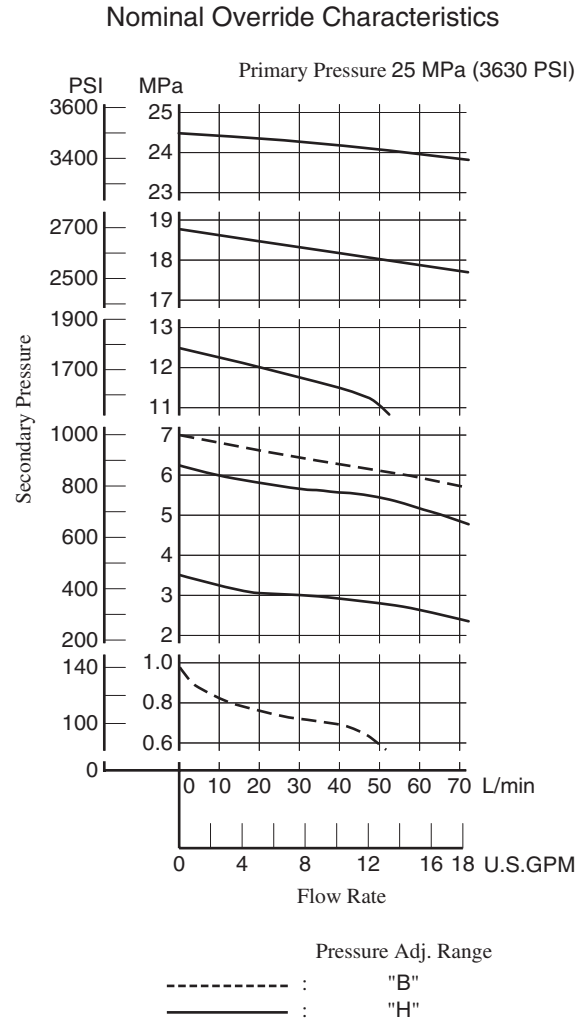
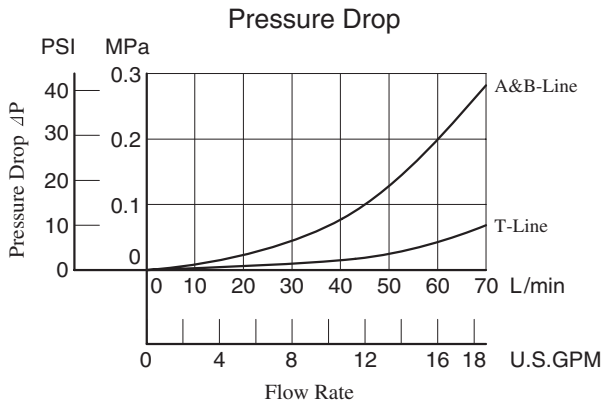

MRP-03-\*-30/3090

MRB-03-\*-30/3090

DIMENSIONS IN MILLIMETRES (INCHES)

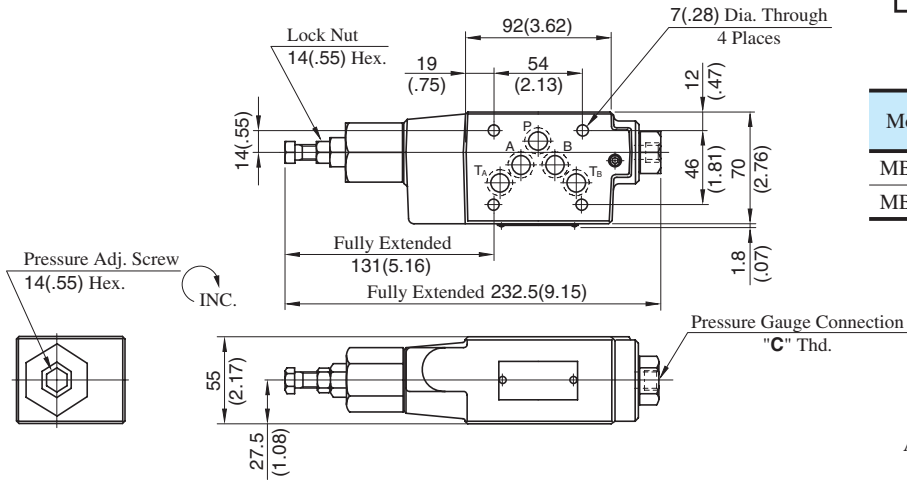

Model Numbers	Thread Size "C" Thd.
MB*-01-*-30	Rc 1/4 = 1/4 BSP.Tr
MB*-01-*-3090	1/4 NPT

Approx. Mass.....3.3 kg (7.5 lbs.)

MRA-03-\*-30/3090

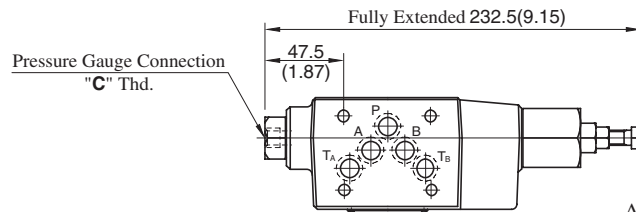

Approx. Mass.....3.3 kg (7.5 lbs.)

• For other dimensions, refer to "MRP-03" drawing above.

## Spare Parts List

MRP-03-\*-30/3090

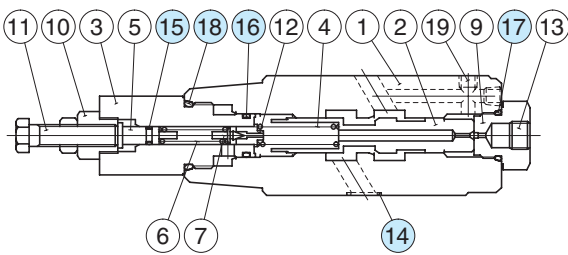

MRB-03-\*-30/3090

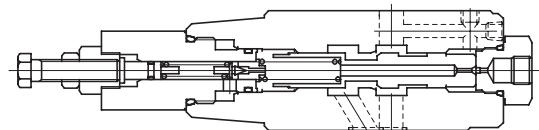

MRA-03-\*-30/3090

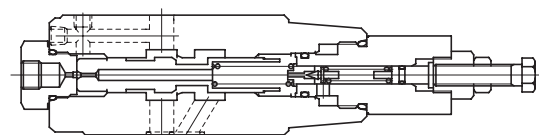

### List of Seals

Item	Name of Parts	Part Numbers	Qty.	Remarks
14	O-Ring	SO-NB-A014	5	Included in Seal Kit Kit No.: KS-MRP-03-30
15	O-Ring	SO-NA-P6	1	
16	O-Ring	SO-NB-P16	1	
17	O-Ring	SO-NB-P18	1	
18	O-Ring	SO-NB-P26	1	

## Reducing Modular Valves For Low Pressure Setting

### Specifications

Model Numbers	Max. Operating Pressure MPa (PSI)	Pres. Adj. Range MPa (PSI)	Max. Flow L/min (U.S.GPM)
MRLP-03-10/1080/1090 MRLA-03-10/1080/1090 MRLB-03-10/1080/1090	7 (1020)	0.2-6.5 (29-940)	50 (13.2) *

★ When pressure setting is less than 0.8 MPa (116 PSI), maximum flow decreases. See "Min. Adjustment Pressure vs. Max. Flow" on the [next page](#) for the appropriate range.

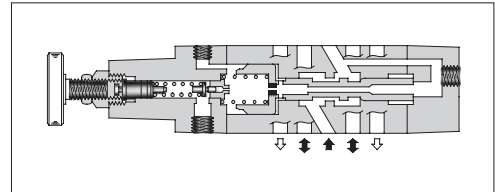
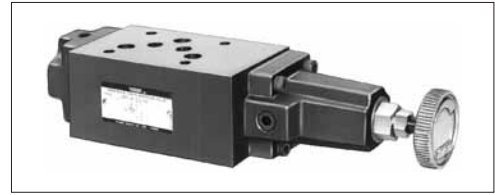

### Model Number Designation

F-	MRLP	-03	-10	*
Special Seals	Series Number	Valve Size	Design Number	Design Standard
<b>F:</b> Special Seals for Phosphate Ester Type Fluids (Omit if not required)	<b>MRLP</b> : Low Pressure Setting Type Reducing Valve for P-Line <b>MRLA</b> : Low Pressure Setting Type Reducing Valve for A-Line <b>MRLB</b> : Low Pressure Setting Type Reducing Valve for B-Line	<b>03</b>	<b>10</b>	Refer to ★

★ Design Standards: None ..... Japanese Standard "JIS"  
80 ..... European Design Standard  
90 ..... N. American Design Standard

### Instructions

- If there is a pressure in drain line, it is added to the secondary setting pressure. Hence, drain line must be connected to tank directly with a low back pressure close to atmospheric pressure.
- To make pressure adjustment, loosen the lock nut and turn the pressure adjustment handle clockwise or anti-clockwise. For an increase of pressure, turn the handle clockwise. Be sure to re-tighten the lock nut firmly after making adjustment to the pressure.

Model Numbers	Graphic Symbols	Detailed Graphic Symbols
MRLP-03		
MRLA-03		
MRLB-03		



## Typical Performance Characteristics

Hydraulic Fluid: Viscosity 35 mm<sup>2</sup>/s (164 SSU), Specific Gravity 0.850

Pres. Drop at Spool Fully Open (P-Line)

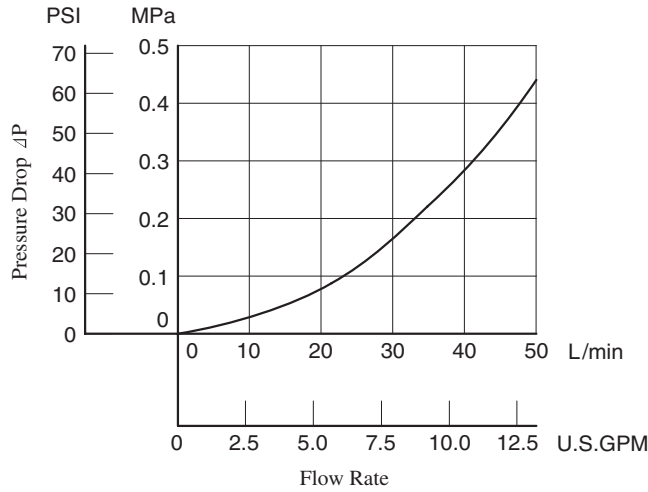

Pressure Drop

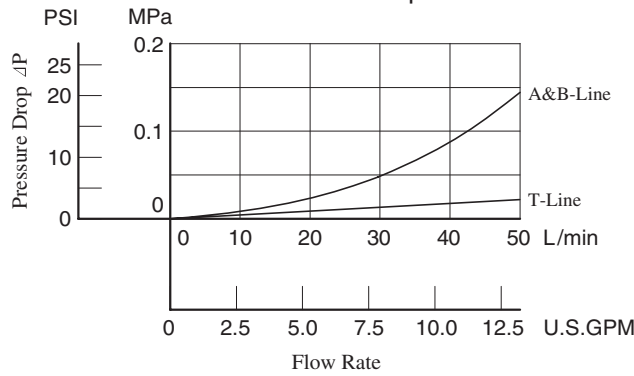

Min. Adjustment Pressure vs. Max. Flow

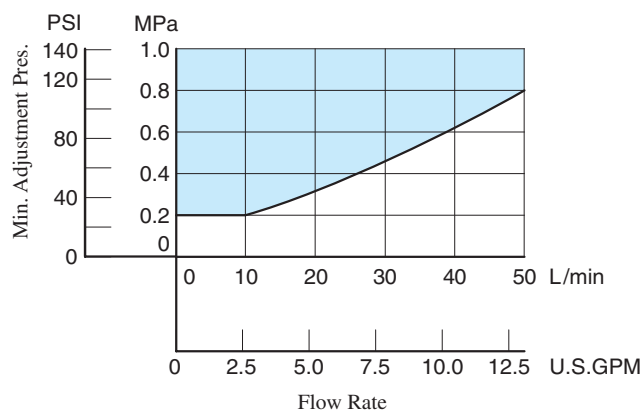

MRLP-03-10/1080/1090  
MRLB-03-10/1080/1090

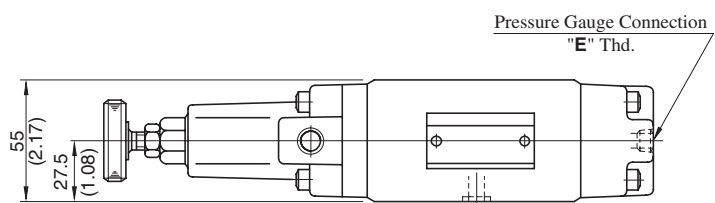
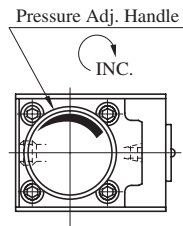
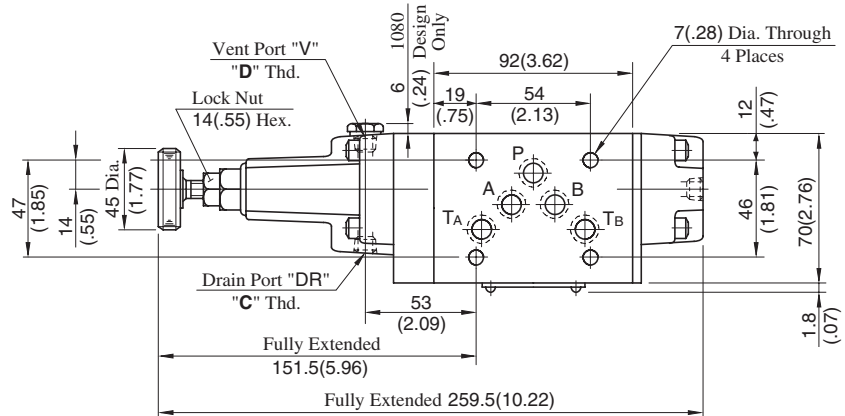

Approx. Mass.....4.5 kg (9.9 lbs.)

Model Numbers	Thread Size		
	"C" Thd.	"D" Thd.	"E" Thd.
MRL*-03-10	Rc 1/4	Rc 1/8	Rc 1/4
MRL*-03-1080	1/4 BSP.F	1/8 BSP.F	1/4 BSP.Tr
MRL*-03-1090	1/4 NPT	1/8 NPT	1/4 NPT

**DIMENSIONS IN MILLIMETRES (INCHES)**

MRLA-03-10/1080/1090

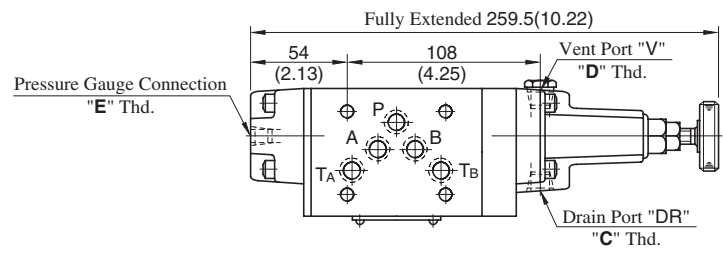

Approx. Mass.....4.5 kg (9.9 lbs.)

- For other dimensions, refer to "MRLP-03" drawing above.

## Spare Parts List

MRLP-03-10/1080/1090  
MRLB-03-10/1080/1090

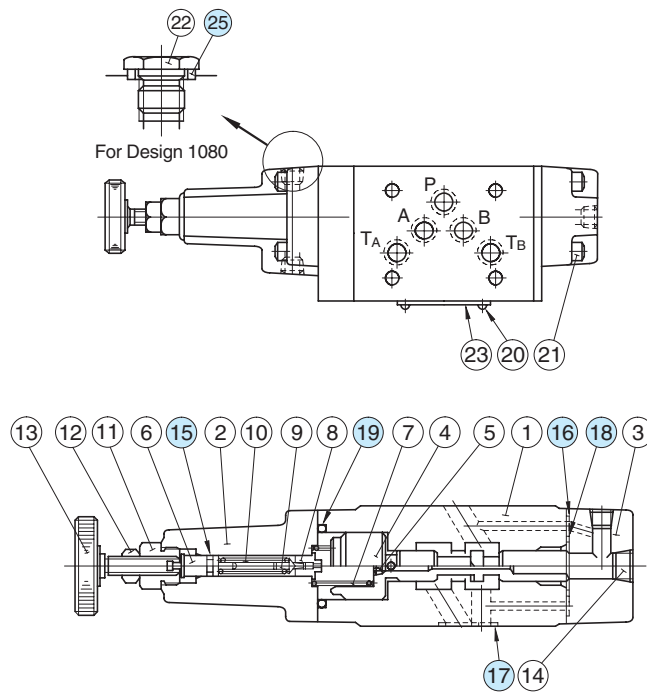

MRLA-03-10/1080/1090

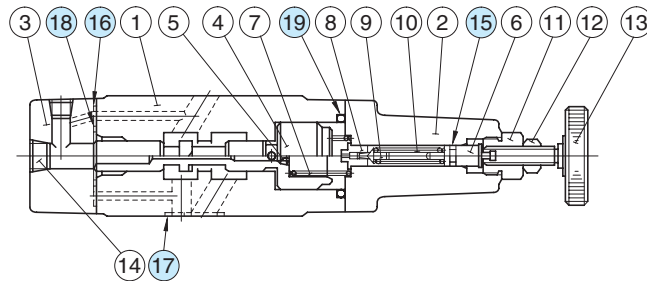

### List of Seals

Item	Name of Parts	Part Numbers	Qty.	Remarks
15	O-Ring	SO-NA-P6	1	Included in Seal Kit Kit No.:KS-MRLP-03-10
16	O-Ring	SO-NB-P6	2	
17	O-Ring	SO-NB-A014	5	
18	O-Ring	SO-NB-P22	1	
19	O-Ring	SO-NB-P32	1	
25	Bonded Seal	SG-FB-1/8	1	

Note: No bonded seal are included in seal kits.

## Sequence Modular Valves/Counterbalance Modular Valves

### Specifications

Model Numbers	Max. Operating Pressure MPa (PSI)	Max. Flow L/min (U.S.GPM)	Max. Free Flow L/min (U.S.GPM)
MHP-03-* -20	25 (3630)	50 (13.2)	—
MHA-03-* -20 MHB-03-* -20			70 (18.5)

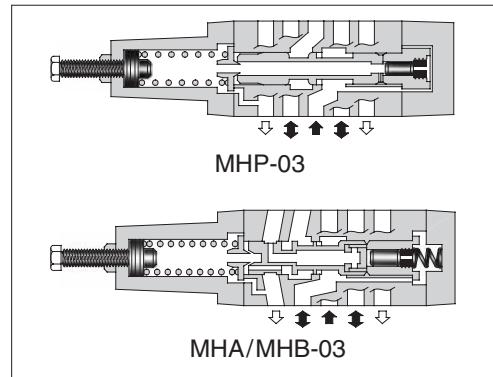

### Model Number Designation

<b>F-</b>	<b>MHA</b>	<b>-03</b>	<b>-C</b>	<b>-20</b>	<b>*</b>
Special Seals	Series Number	Valve Size	Pres. Adj. Range MPa (PSI)	Design Number	Design Standard
<b>F:</b> Special Seals for Phosphate Ester Type Fluids (Omit if not required)	<b>MHP:</b> Sequence Valve for P-Line	<b>03</b>	<b>N:</b> *-1.8 (*-260) ★ <sup>1</sup> <b>A:</b> 1.8-3.5 (260-510) <b>B:</b> 3.5-7 (510-1020) <b>C:</b> 7-14 (1020-2030)	<b>20</b>	Refer to ★ <sup>2</sup>
	<b>MHA:</b> Counterbalance Valve for A-Line <b>MHB:</b> Counterbalance Valve for B-Line			<b>20</b>	

★<sup>1</sup>. See the "Minimum Adjustment Pressure" of the next page for the item marked \*.

★<sup>2</sup>. Design Standards: None ..... Japanese Standard "JIS", European Design Standard and N. American Design Standard

### Instructions

- The minimum adjustment pressure equals the value obtained from the minimum adjustment pressure characteristics plus the tank line back pressure of the next page. This back pressure should include the value of the T-line pressure drop characteristics of the valves stacked to the base plate side of the modular valve.
- To make pressure adjustment, loosen the lock nut and turn the pressure adjustment screw clockwise or anti-clockwise. For an increase of pressure, turn the screw clockwise. Be sure to re-tighten the lock nut firmly after making adjustment to the pressure.

Model Numbers	Graphic Symbols	Detailed Graphic Symbols
MHP-03		
MHA-03		
MHB-03		

## Typical Performance Characteristics

Hydraulic Fluid: Viscosity 35 mm<sup>2</sup>/s (164 SSU), Specific Gravity 0.850

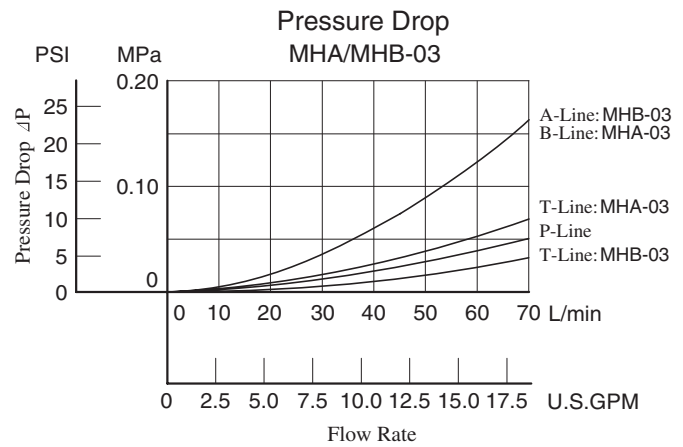
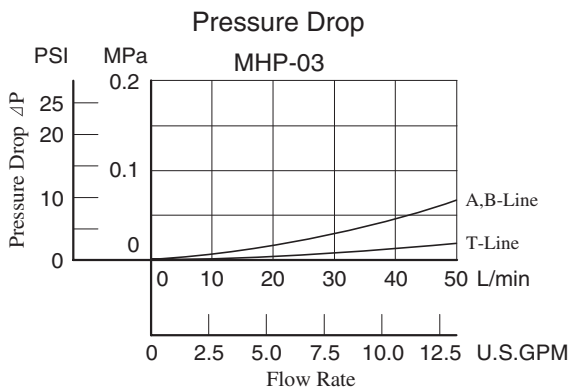
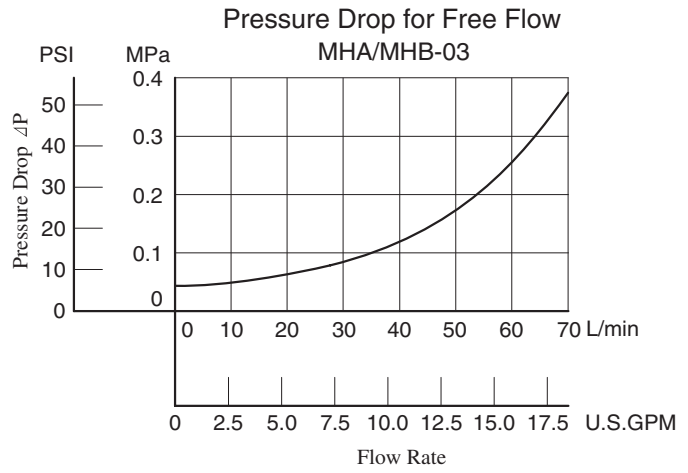
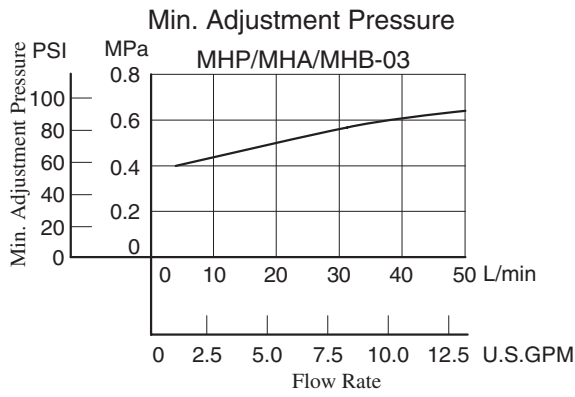

  
  
**03 Series Modular Valves**

**MHP-03-\*-20**

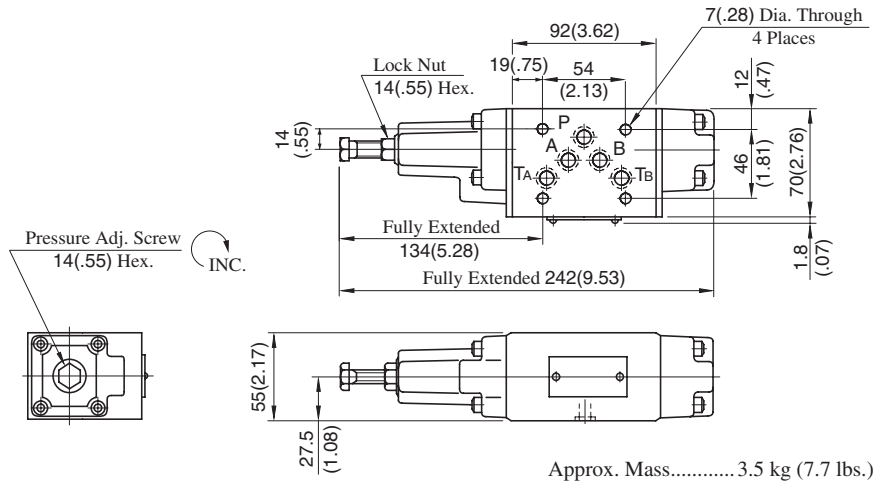

**DIMENSIONS IN  
MILLIMETRES (INCHES)**

**MHA-03-\*-20**

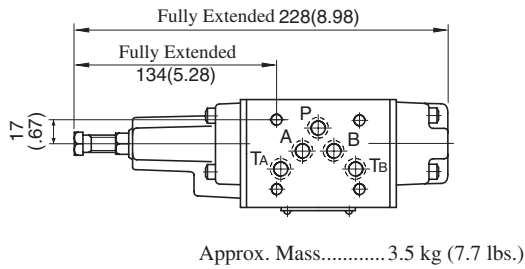

**MHA-03-\*-20**

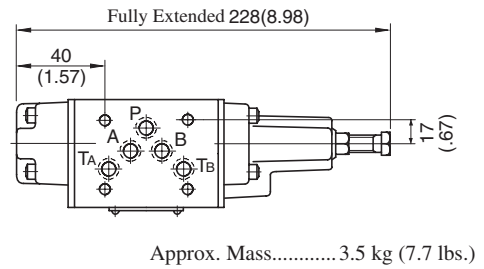

• For other dimensions, refer to "MHP-03" drawing above.

**■ Spare Parts List**

**MHP-03-\*-20**

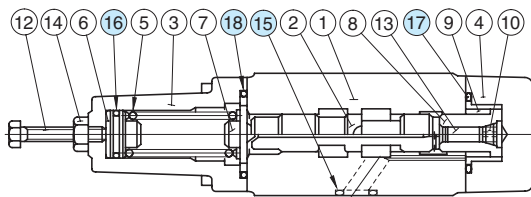

**MHA-03-\*-20**

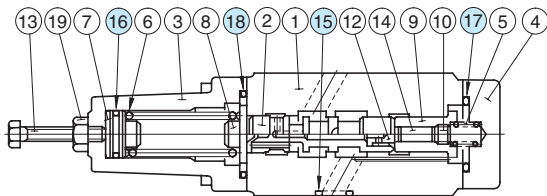

**MHB-03-\*-20**

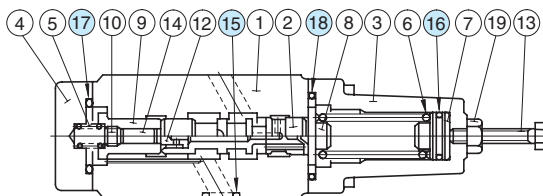

• List of Seals

**MHP-03, MHA-03**

Item	Name of Parts	Part Numbers	Qty.	Remarks
15	O-Ring	SO-NB-A014	5	Included in Seal Kit Kit No.:KS-MHP-03-20
16	O-Ring	SO-NB-P16	1	
17	O-Ring	SO-NB-P29	1	
18	O-Ring	SO-NB-P32	1	

**MHB-03**

Item	Name of Parts	Part Numbers	Qty.	Remarks
15	O-Ring	SO-NB-A014	5	Included in Seal Kit Kit No.:KS-MHB-03-20
16	O-Ring	SO-NA-P16	1	
17	O-Ring	SO-NB-P29	1	
18	O-Ring	SO-NB-P32	1	

## Pressure and Temperature Compensated Flow Control (and Check) Modular Valves

### Specifications

Model Numbers	Max. Operating Pressure MPa (PSI)	Max. Metred Flow L/min (U.S.GPM)	Max. Free Flow L/min (U.S.GPM)
MFP-03-11	16 (2320)	50 (13.2)	—
MFA-03-*-11 MFB-03-*-11 MFW-03-*-11			70 (18.5)

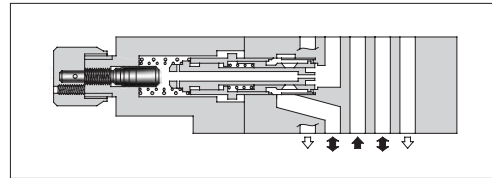

### Model Number Designation

F-	MFA	-03	-X	-11	*
Special Seals	Series Number	Valve Size	Direction of Flow	Design Number	Design Standard
<b>F:</b> Special Seals for Phosphate Ester Type Fluids (Omit if not required)	<b>MFP</b> : Flow Control Valve for P-Line	<b>03</b>	—	<b>11</b>	Refer to ★
	<b>MFA</b> : Flow Control and Check Valve for A-Line <b>MFB</b> : Flow Control and Check Valve for B-Line <b>MFW</b> : Flow Control and Check Valve for A&B-Lines		<b>X</b> : Metre-out <b>Y</b> : Metre-in	<b>11</b>	

★ Design Standards: None ..... Japanese Standard "JIS", European Design Standard and N. American Design Standard

### Instructions

- To make flow rate adjustment, loosen locking screw for the dial and turn the flow adjustment dial clockwise or anti-clockwise. For a decrease of flow, turn the dial clockwise. Be sure to re-tighten the locking screw firmly after the adjustment of the flow rate.

Model No.	Graphic Symbols	Detailed Graphic Symbols	Model No.	Graphic Symbols	Detailed Graphic Symbols																						
MFP-03			<table border="1"> <thead> <tr> <th colspan="2">Metre-out</th> <th colspan="2">Metre-in</th> </tr> </thead> <tbody> <tr> <td>MFA-03-X</td> <td></td> <td></td> <td>MFA-03-Y</td> <td></td> <td></td> </tr> <tr> <td>MFB-03-X</td> <td></td> <td></td> <td>MFB-03-Y</td> <td></td> <td></td> </tr> <tr> <td>MFW-03-X</td> <td></td> <td></td> <td>MFW-03-Y</td> <td></td> <td></td> </tr> </tbody> </table>			Metre-out		Metre-in		MFA-03-X			MFA-03-Y			MFB-03-X			MFB-03-Y			MFW-03-X			MFW-03-Y		
Metre-out		Metre-in																									
MFA-03-X			MFA-03-Y																								
MFB-03-X			MFB-03-Y																								
MFW-03-X			MFW-03-Y																								

**Typical Performance Characteristics**

Hydraulic Fluid: Viscosity 35 mm<sup>2</sup>/s (164 SSU), Specific Gravity 0.850

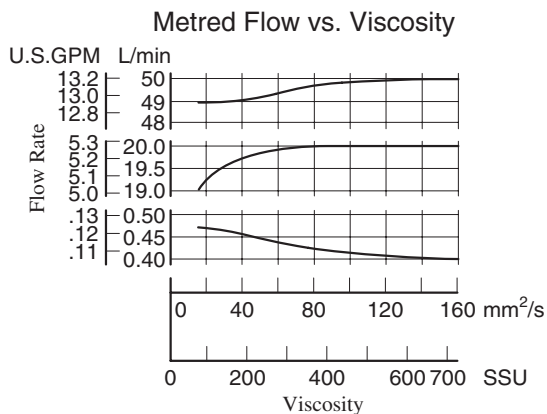
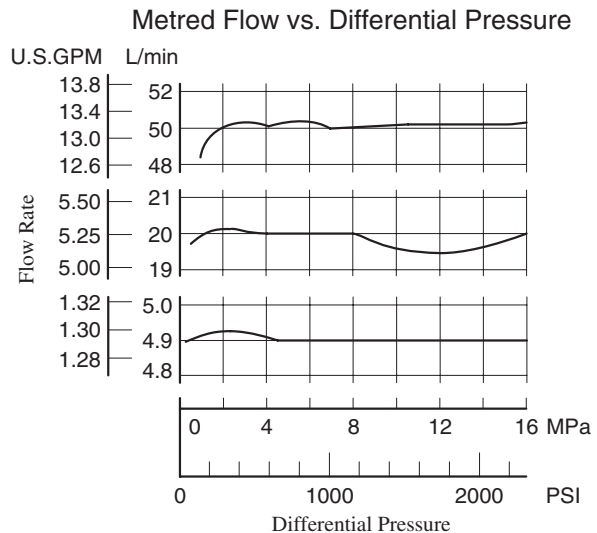
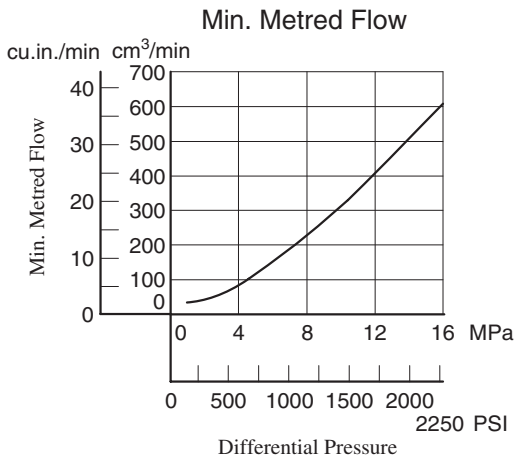
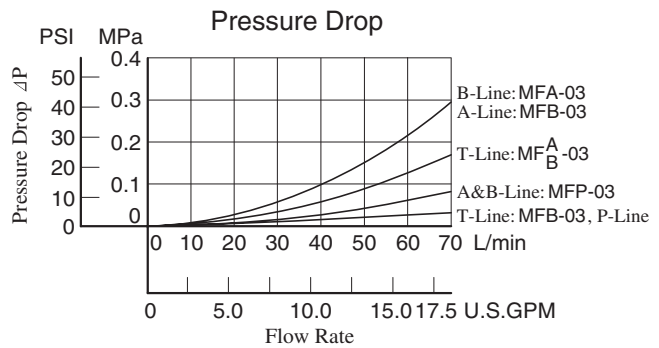
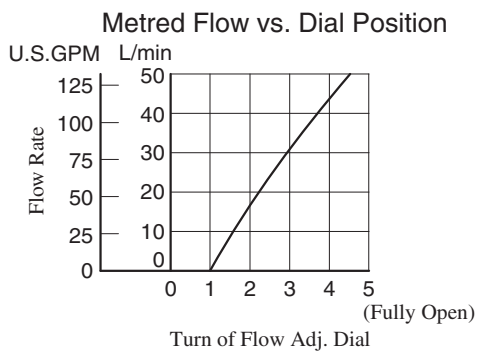
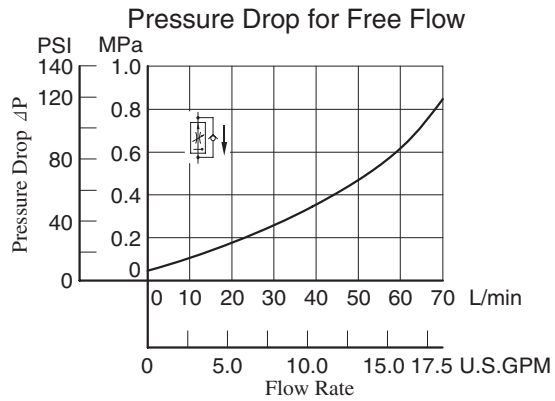
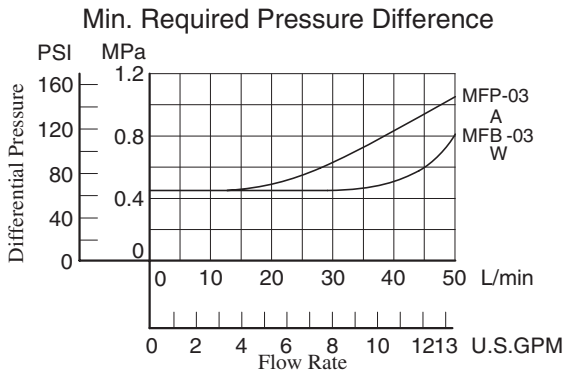



MFP-03-11

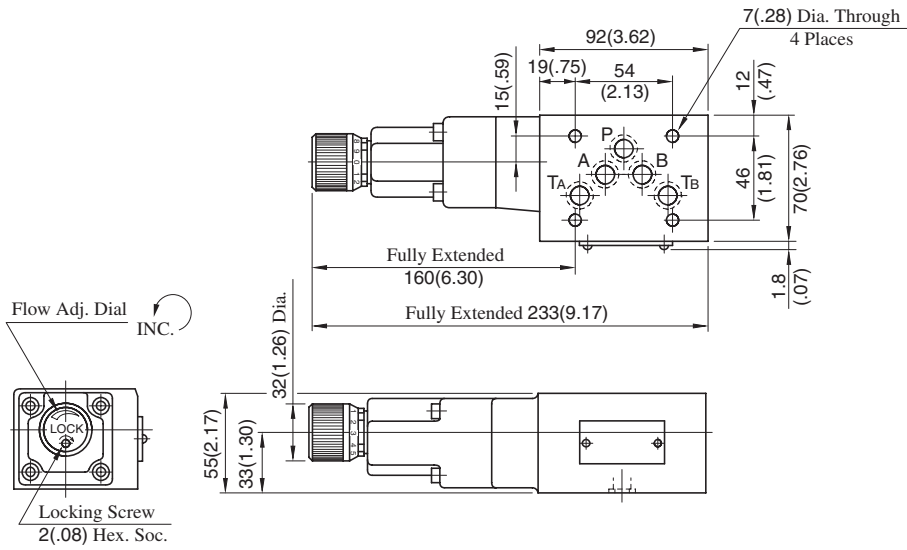

Approx. Mass.....4.2 kg (9.3 lbs.)

MFW-03-X-Y-11

DIMENSIONS IN MILLIMETRES (INCHES)

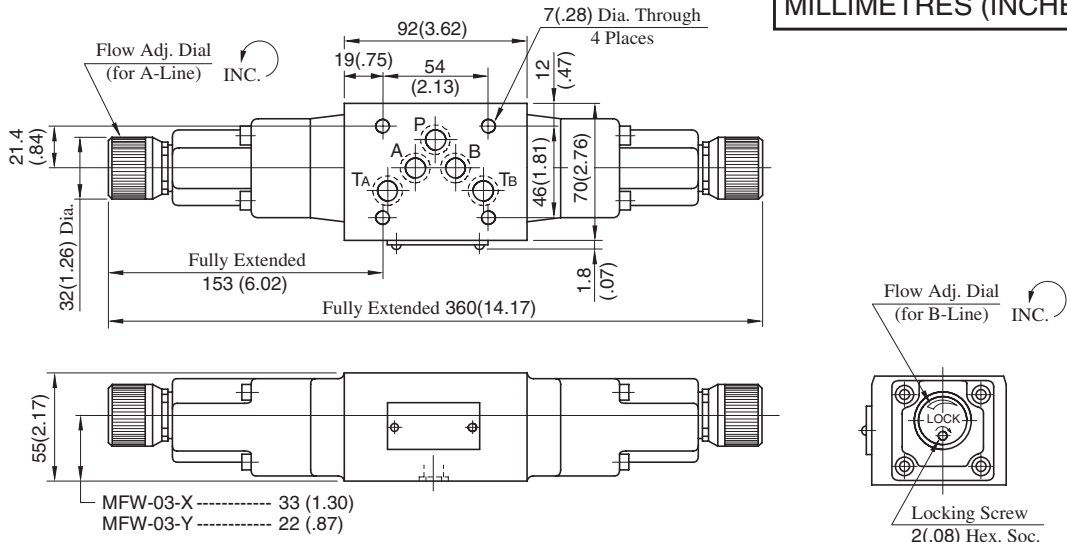

Approx. Mass.....5.2 kg (11.5 lbs.)

MFA-03-X-Y-11

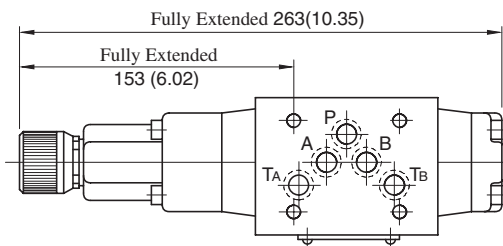

Approx. Mass.....4.1 kg (9.0 lbs.)

MFB-03-X-Y-11

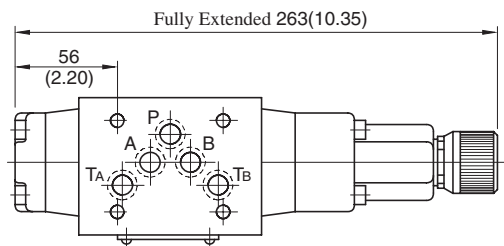

Approx. Mass.....4.1 kg (9.0 lbs.)

• For other dimensions, refer to "MFW-03" drawing above.



03 Series Modular Valves

■ Spare Parts List

MFP-03-11

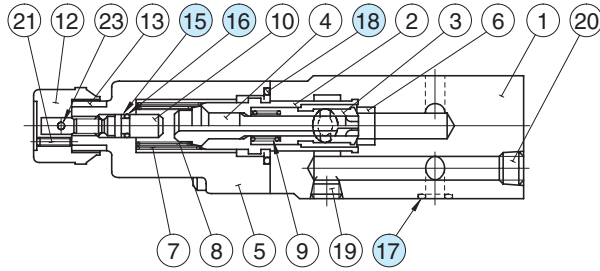

MFA-03-X<sub>Y</sub>-11

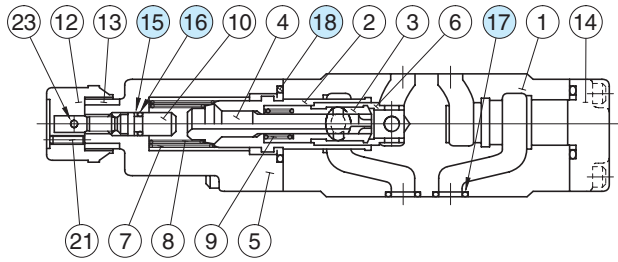

MFB-03-X<sub>Y</sub>-11

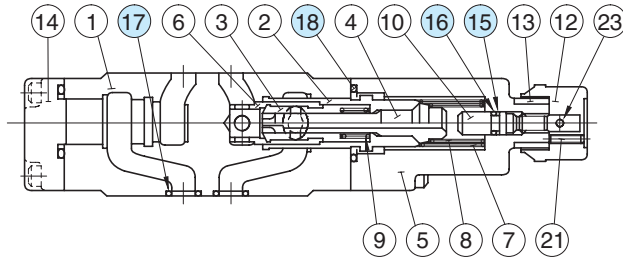

MFW-03-X<sub>Y</sub>-11

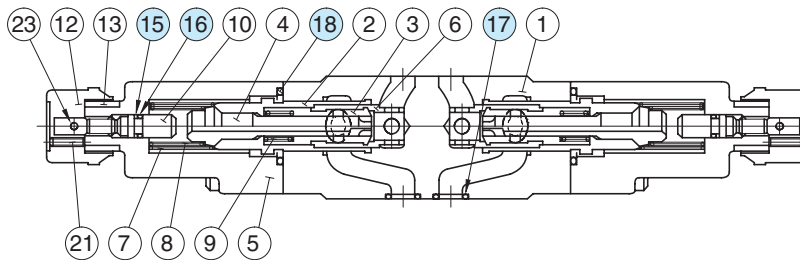

● List of Seals

Item	Name of Parts	Part Numbers	Quantity			
			MFP-03	MFA-03	MFB-03	MFW-03
15	Back Up Ring	SO-BB-P6	1	1	1	2
16	O-Ring	SO-NA-P6	1	1	1	2
17	O-Ring	SO-NB-A014	5	5	5	5
18	O-Ring	SO-NB-P28	1	2	2	2

● List of Seal Kits

Valve Model Numbers	Seal Kit Numbers
MFP-03	KS-MFP-03-10
MFA-03	KS-MFA-03-10
MFB-03	
MFW-03	KS-MFW-03-10

Note: When ordering seals, please specify the seal kit number from the table right.

## Temperature Compensated Throttle and Check Modular Valves

### Specifications

Model Numbers	Max. Operating Pressure MPa (PSI)	Max. Differential Pressure MPa (PSI)	Max. Metred Flow L/min (U.S.GPM)	Min. Metred Flow L/min (U.S.GPM)	Max. Free Flow L/min (U.S.GPM)
MSTA-03-X-20 MSTB-03-X-20 MSTW-03-X-20	25 (3630)	25 (3630)	70 (18.5)	2 (.53) {1 (.26)}*	70 (18.5)

\*The figures in parentheses are the values when the differential pressure is less than 3.5 MPa (510 PSI).

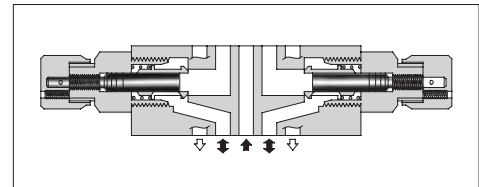

### Model Number Designation

F-	MSTA	-03	-X	-20	*
Special Seals	Series Number	Valve Size	Direction of Flow	Design Number	Design Standard
<b>F:</b> Special Seals for Phosphate Ester Type Fluids (Omit if not required)	<b>MSTA</b> : Temperature Compensated Throttle and Check Valve for A-Line <b>MSTB</b> : Temperature Compensated Throttle and Check Valve for B-Line <b>MSTW</b> : Temperature Compensated Throttle and Check Valve for A&B-Lines	<b>03</b>	<b>X</b> : Metre-out	<b>20</b>	Refer to ★

★ Design Standards: None ..... Japanese Standard "JIS", European Design Standard and N. American Design Standard

### Instructions

- To make flow rate adjustment, loosen locking screw for the dial and turn the flow adjustment dial clockwise or anti-clockwise. For a decrease of flow, turn the dial clockwise. Be sure to re-tighten the locking screw firmly after the adjustment of the flow rate.

Model No.	Graphic Symbols	Detailed Graphic Symbols
	Metre-out	
MSTA-03-X		
MSTB-03-X		
MSTW-03-X		

**Typical Performance Characteristics**

Hydraulic Fluid: Viscosity 35 mm<sup>2</sup>/s (164 SSU), Specific Gravity 0.850

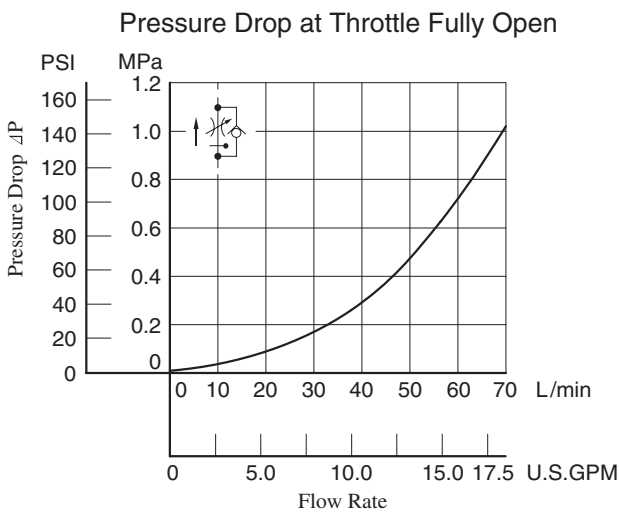
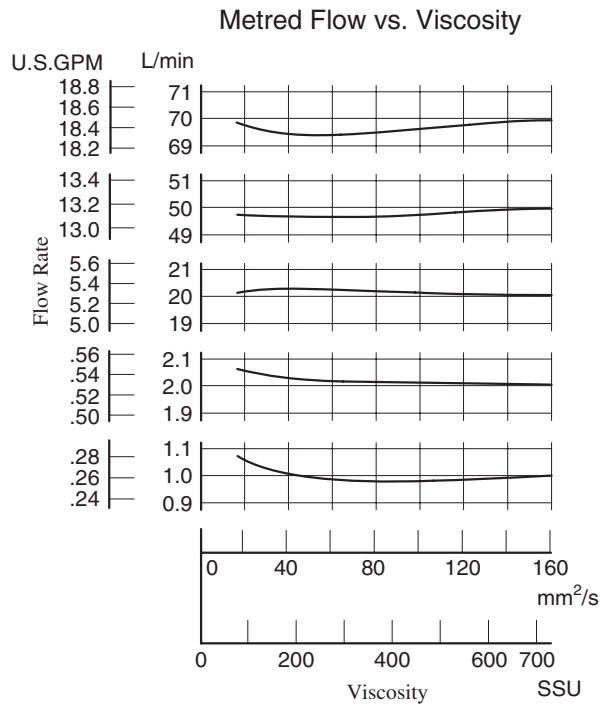
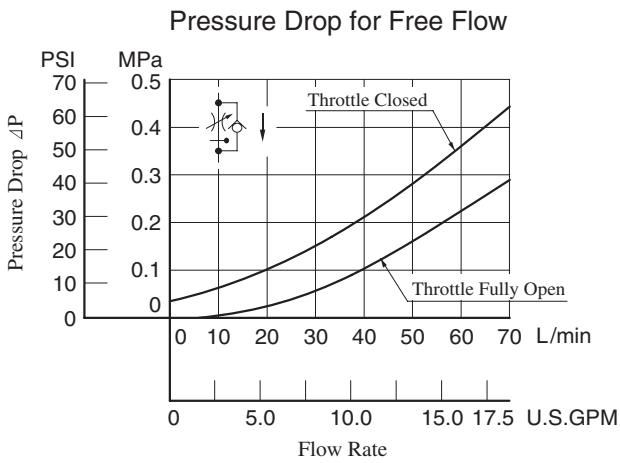
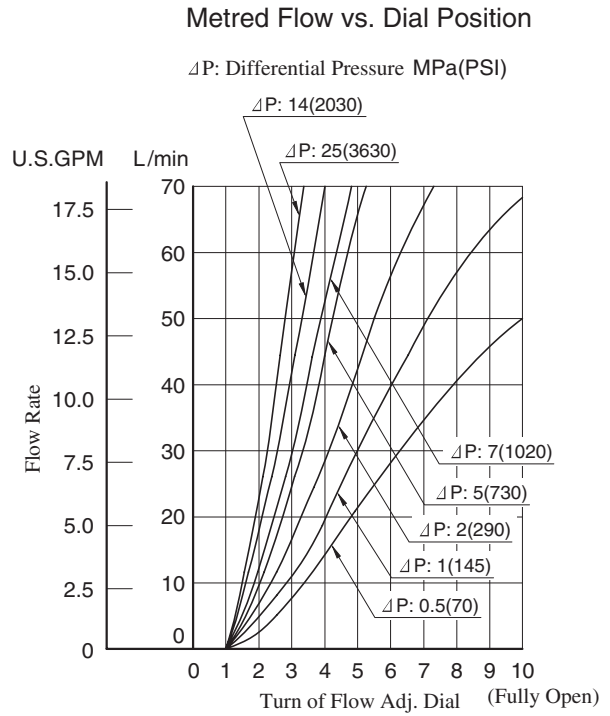
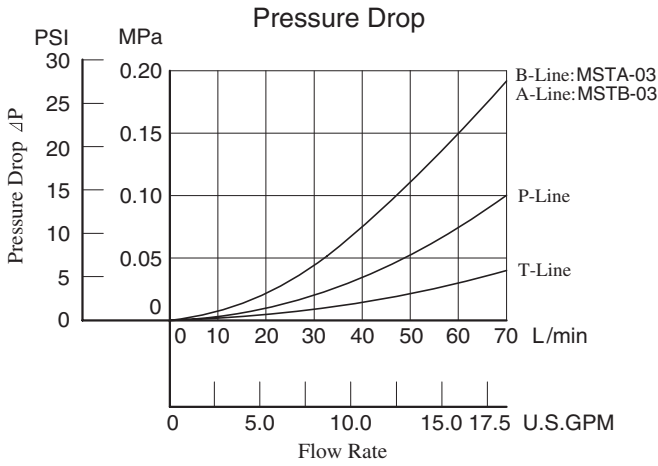

### MSTW-03-X-20

**DIMENSIONS IN  
MILLIMETRES (INCHES)**

Approx. Mass..... 3.7 kg (8.2 lbs.)

### MSTA-03-X-20

Approx. Mass..... 3.5 kg (7.7 lbs.)

- For other dimensions, refer to "MSTW-03" drawing left.

---

### MSTB-03-X-20

Approx. Mass..... 3.5 kg (7.7 lbs.)

- For other dimensions, refer to "MSTW-03" drawing left.

## ■ Spare Parts List

### MSTA-03-X-20

### MSTB-03-X-20

### MSTW-03-X-20

#### ● List of Seals

Item	Name of Parts	Part Numbers	Quantity		
			MSTA-03	MSTB-03	MSTW-03
12	Back Up Ring	900-VK411915-2	1	1	2
13	O-Ring	SO-NA-P7	1	1	2
14	O-Ring	SO-NB-A014	5	5	5
15	O-Ring	SO-NB-P24	2	2	2

Note: When ordering seals, please specify the seal kit number from the table right.

#### ● List of Seal Kits

Valve Model Numbers	Seal Kit Numbers
MSTA-03	KS-MSTA-03-20
MSTB-03	
MSTW-03	KS-MSTW-03-20

## Throttle Modular Valves

### Specifications

Model Number	Max. Operating Pressure MPa (PSI)	Max. Flow L/min (U.S.GPM)
MSP-03-30	25 (3630)	70 (18.5) *

★ Maximum flow decreases when the differential pressure is less than 1 MPa (145 PSI).  
See "Pressure Drop at Throttle Fully Open".

### Model Number Designation

F-	MSP	-03	-30	*
Special Seals	Series Number	Valve Size	Design Number	Design Standard
<b>F:</b> Special Seals for Phosphate Ester Type Fluids (Omit if not required)	<b>MSP :</b> Throttle Valve for P-Line	<b>03</b>	<b>30</b>	Refer to ★

★ Design Standards: None ..... Japanese Standard "JIS", European Design Standard and N. American Design Standard

### Typical Performance Characteristics

Hydraulic Fluid: Viscosity 35 mm<sup>2</sup>/s (164 SSU), Specific Gravity 0.850

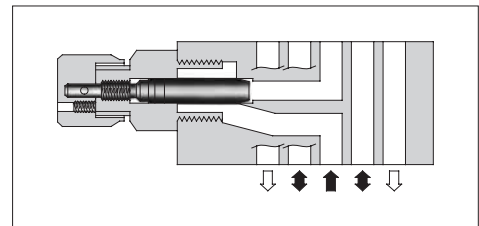
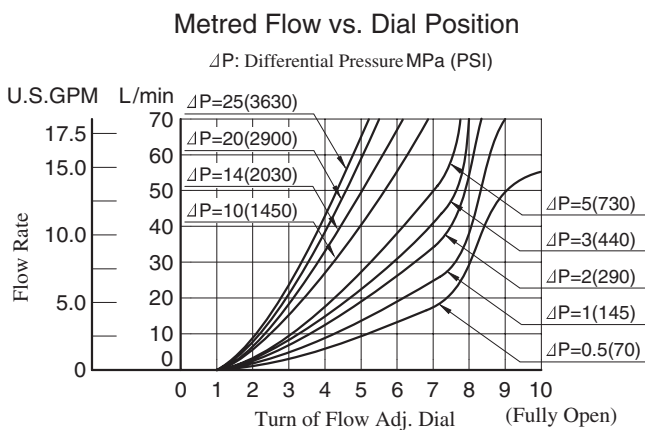
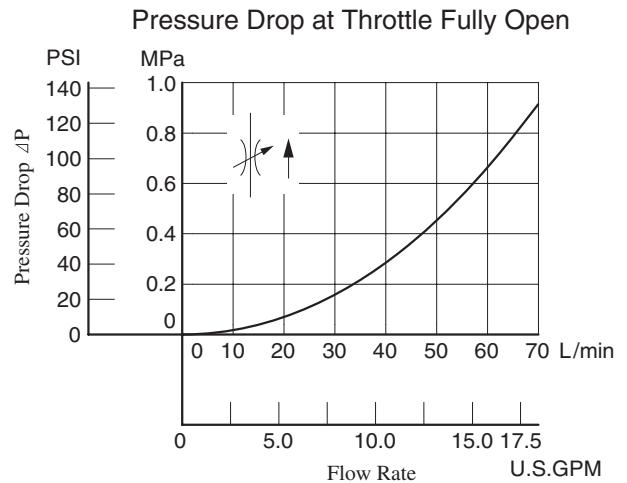
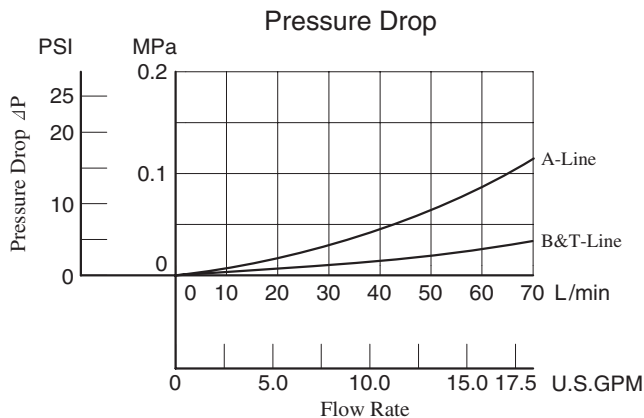

Graphic Symbol

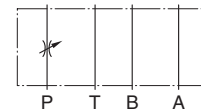

Detailed Graphic Symbol

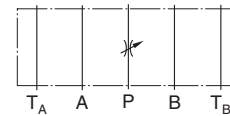

### Instructions

- To make flow rate adjustment, loosen locking screw for the dial and turn the flow adjustment dial clockwise or anti-clockwise. For a decrease of flow, turn the dial clockwise. Be sure to re-tighten the locking screw firmly after the adjustment of the flow rate.

MSP-03-30

**DIMENSIONS IN  
MILLIMETRES (INCHES)**

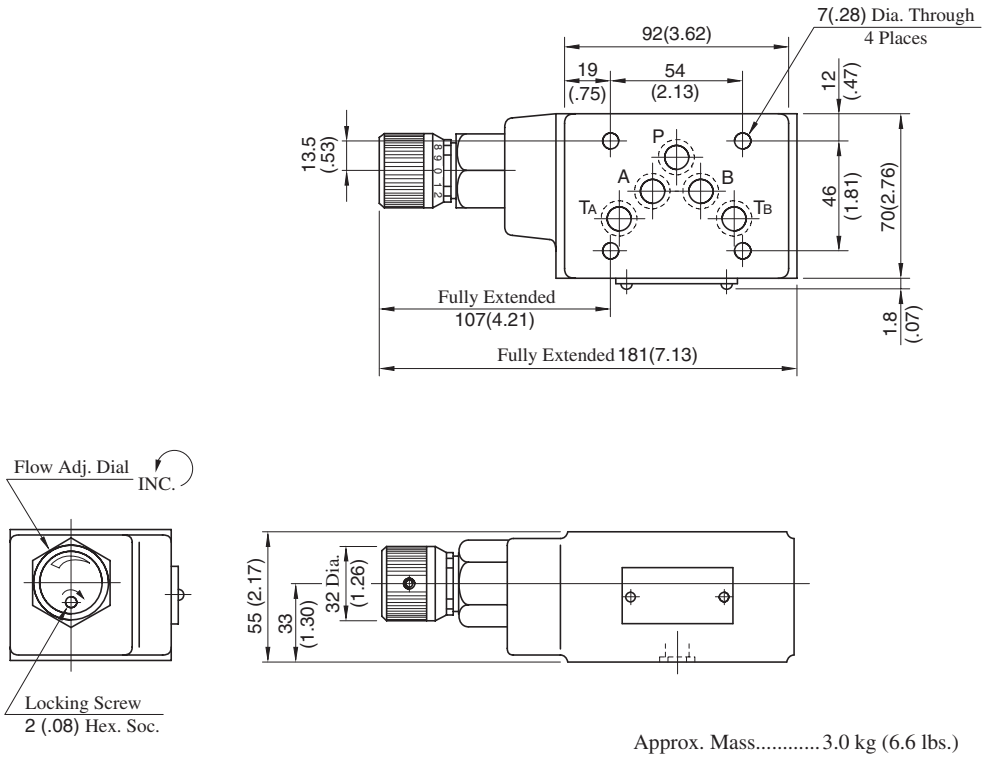

## ■ Spare Parts List

MSP-03-30

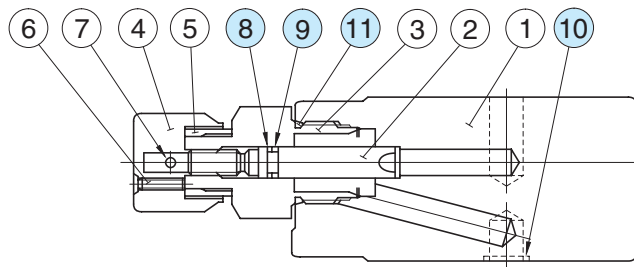

### ● List of Seals

Item	Name of Parts	Part Numbers	Qty.	Remarks
8	Back Up Ring	900-VK411915-2	1	Included in Seal Kit Kit No.: KS-MSP-03-30
9	O-Ring	SO-NA-P7	1	
10	O-Ring	SO-NB-A014	5	
11	O-Ring	SO-NB-P24	1	

## Check and Throttle Modular Valves

### Specifications

Model Number	Max. Operating Pressure MPa (PSI)	Max. Flow L/min (U.S.GPM)
MSCP-03-20	25 (3630)	70 (18.5) *

★ Maximum flow decreases when the differential pressure is less than 1 MPa (145 PSI).  
See "Pressure Drop at Throttle Fully Open".

### Model Number Designation

F-	MSCP	-03	-20	*
Special Seals	Series Number	Valve Size	Design Number	Design Standard
<b>F:</b> Special Seals for Phosphate Ester Type Fluids (Omit if not required)	<b>MSCP :</b> Check and Throttle Valve for P-Line	<b>03</b>	<b>20</b>	Refer to ★

★ Design Standards: None ..... Japanese Standard "JIS", European Design Standard and N. American Design Standard

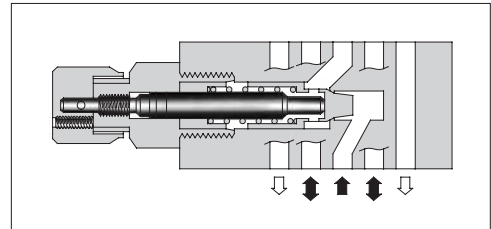

Graphic Symbol

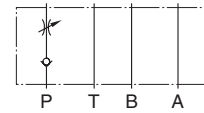

Detailed Graphic Symbol

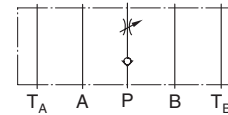

### Typical Performance Characteristics

Hydraulic Fluid: Viscosity 35 mm<sup>2</sup>/s (164 SSU), Specific Gravity 0.850

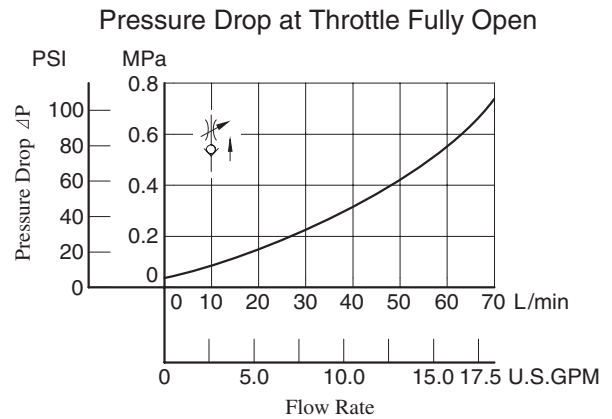
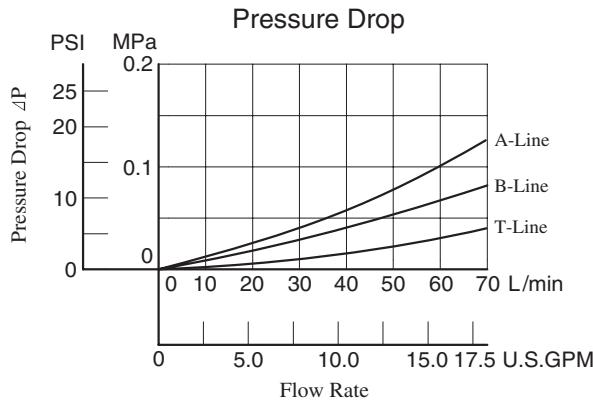

Metred Flow vs. Dial Position

ΔP: Differential Pressure MPa (PSI)

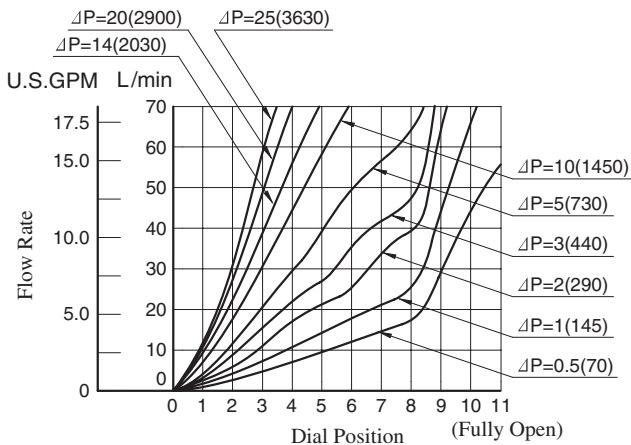

### Instructions

- To make flow rate adjustment, loosen locking screw for the dial and turn the flow adjustment dial clockwise or anti-clockwise. For a decrease of flow, turn the dial clockwise. Be sure to re-tighten the locking screw firmly after the adjustment of the flow rate.



MSCP-03-20

**DIMENSIONS IN  
MILLIMETRES (INCHES)**

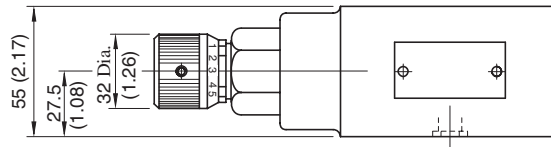
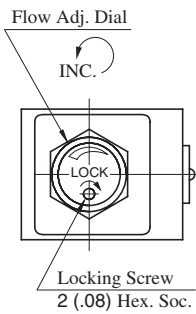
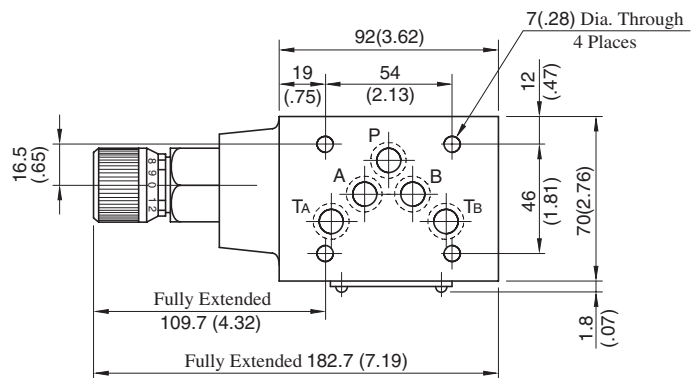

Approx. Mass..... 3.0 kg (6.6 lbs.)

## ■ Spare Parts List

MSCP-03-20

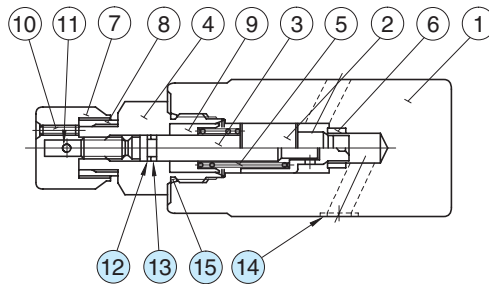

### ● List of Seals

Item	Name of Parts	Part Numbers	Qty.	Remarks
12	Back Up Ring	900-VK411915-2	1	Included in Seal Kit Kit No.: KS-MSP-03-30
13	O-Ring	SO-NA-P7	1	
14	O-Ring	SO-NB-A014	5	
15	O-Ring	SO-NB-P24	1	

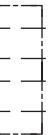

03 Series Modular Valves

## Throttle and Check Modular Valves

### Specifications

Model Numbers	Max. Operating Pressure MPa (PSI)	Max. Flow L/min (U.S.GPM)
MSA-03-*-40 MSB-03-*-40 MSW-03-*-40	25 (3630)	120 (31.7)

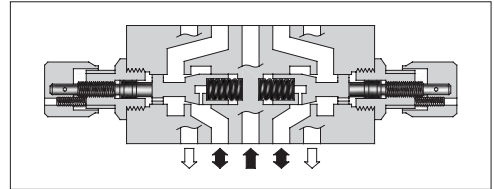

### Model Number Designation

F-	MSW	-03	-X	-40	*
Special Seals	Series Number	Valve Size	Direction of Flow	Design Number	Design Standard
<b>F:</b> Special Seals for Phosphate Ester Type Fluids (Omit if not required)	<b>MSA</b> : Throttle and Check Valve for A-Line <b>MSB</b> : Throttle and Check Valve for B-Line <b>MSW</b> : Throttle and Check Valve for A&B-Lines	<b>03</b>	<b>X</b> : Metre-out <b>Y</b> : Metre-in	<b>40</b>	Refer to ★

★ Design Standards: None ..... Japanese Standard "JIS", European Design Standard and N. American Design Standard

### Instructions

- To make flow rate adjustment, loosen locking screw for the dial and turn the flow adjustment dial clockwise or anti-clockwise. For a decrease of flow, turn the dial clockwise. Be sure to re-tighten the locking screw firmly after the adjustment of the flow rate.

Model No.	Graphic Symbols	Detailed Graphic Symbols	Model No.	Graphic Symbols	Detailed Graphic Symbols
	Metre-out			Metre-in	
MSA-03-X			MSA-03-Y		
MSB-03-X			MSB-03-Y		
MSW-03-X			MSW-03-Y		

## Typical Performance Characteristics

Hydraulic Fluid: Viscosity 35 mm<sup>2</sup>/s (164 SSU), Specific Gravity 0.850

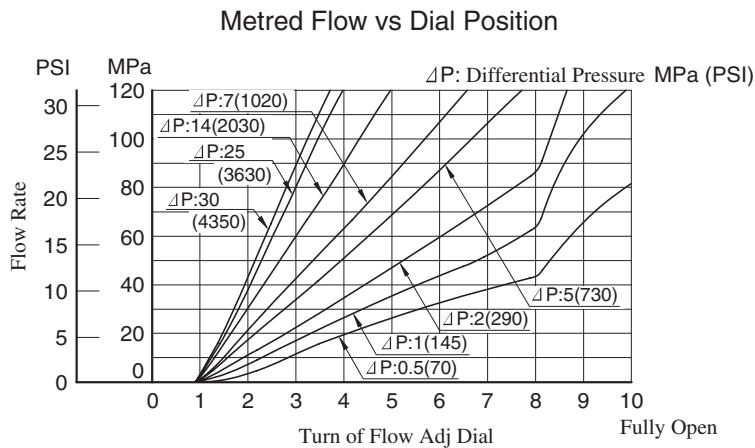
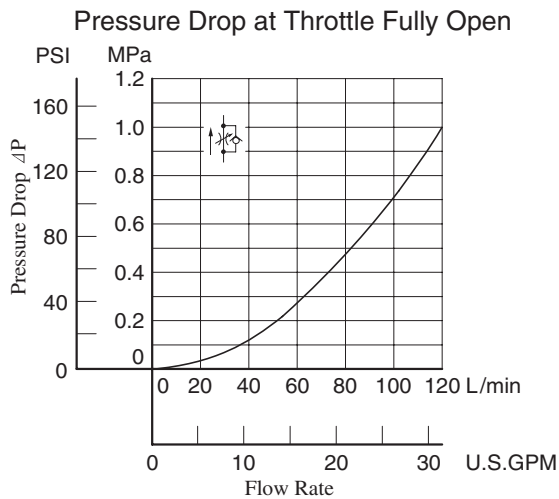
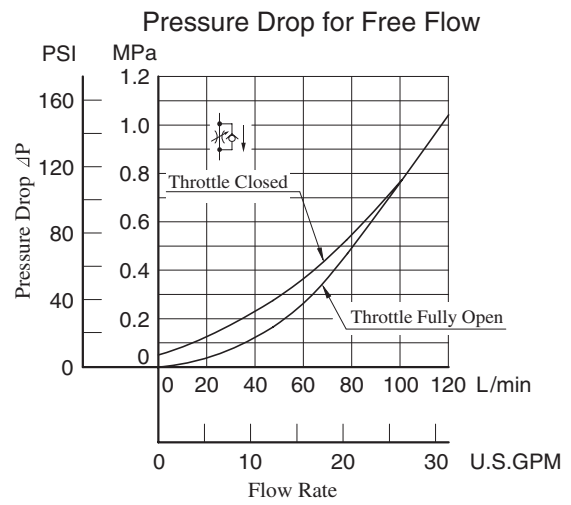
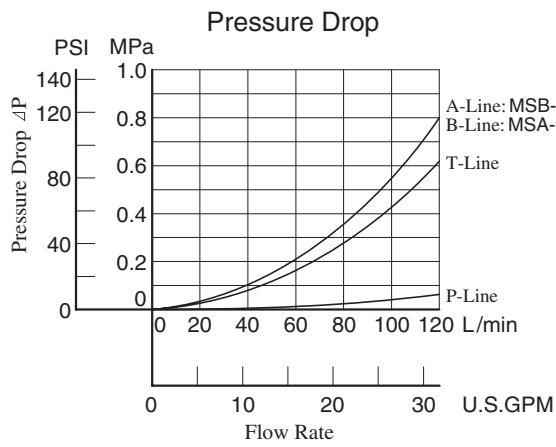

**MSW-03-X<sub>Y</sub>-40**

**DIMENSIONS IN MILLIMETRES (INCHES)**

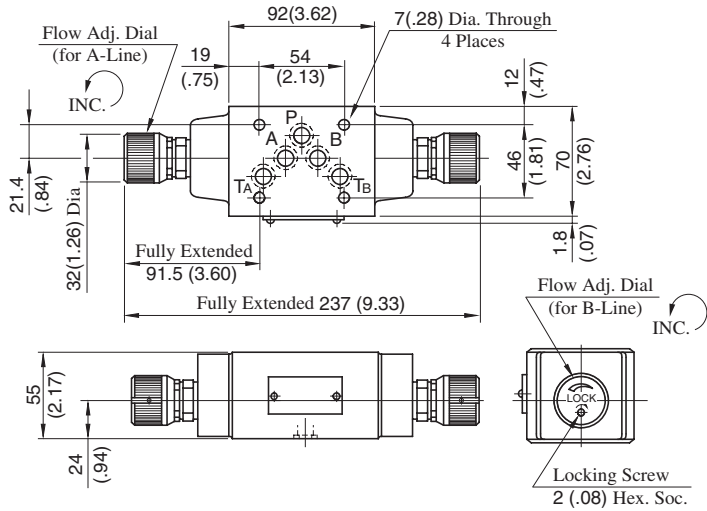

Approx. Mass.....3.7 kg (8.2 lbs.)

**MSA-03-X<sub>Y</sub>-40**

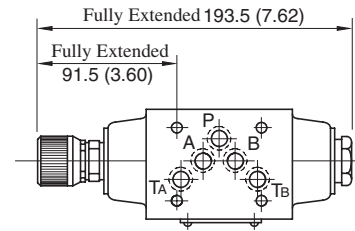

Approx. Mass.....3.5 kg (7.7 lbs.)

• For other dimensions, refer to "MSW-03" drawing left.

**MSB-03-X<sub>Y</sub>-40**

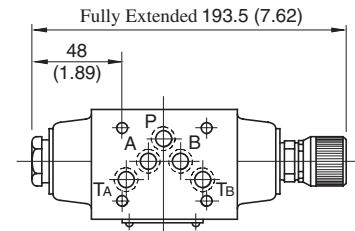

Approx. Mass.....3.5 kg (7.7 lbs.)

• For other dimensions, refer to "MSW-03" drawing left.

**Spare Parts List**

**MSA-03-X<sub>Y</sub>-40**

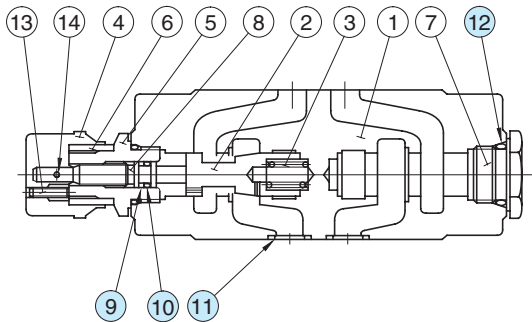

**MSB-03-X<sub>Y</sub>-40**

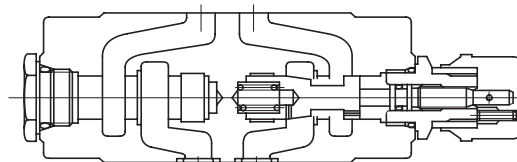

**MSW-03-X<sub>Y</sub>-40**

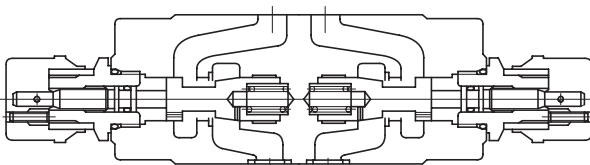

• **List of Seals**

Item	Name of Parts	Part Numbers	Quantity		
			MSA-03	MSB-03	MSW-03
9	Back Up Ring	SO-BB-P8	1	1	2
10	O-Ring	SO-NA-P8	1	1	2
11	O-Ring	SO-NB-A014	5	5	5
12	O-Ring	SO-NB-P18	2	2	2

Note: When ordering seals, please specify the seal kit number from the table right.

• **List of Seal Kits**

Valve Model Numbers	Seal Kit Numbers
MSA-03	KS-MSA-03-40
MSB-03	
MSW-03	KS-MSW-03-40

## Check Modular Valves

### Specifications

Model Numbers	Max. Operating Pressure MPa (PSI)	Max. Flow L/min (U.S.GPM)
MCP-03-*-10 MCA-03-*-20 MCB-03-*-20 MCT-03-*-10	25 (3630)	70 (18.5)

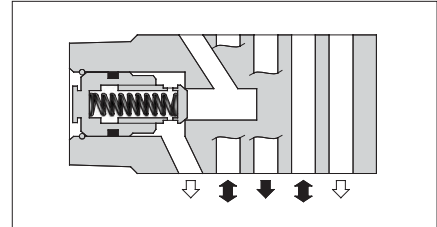

### Model Number Designation

F-	MCP	-03	-0	-10	*
Special Seals	Series Number	Valve Size	Cracking Pressure MPa(PSI)	Design Number	Design Standard
F: Special Seals for Phosphate Ester Type Fluids (Omit if not required)	MCP: Check Valve for P-Line	03	0: 0.035(5) 2: 0.2(29)	10	Refer to ★
	MCA: Check Valve for A-Line			20	
	MCB: Check Valve for B-Line			10	
	MCT: Check Valve for T-Line				

★ Design Standards: None ..... Japanese Standard "JIS", European Design Standard and N. American Design Standard

### Typical Performance Characteristics

Hydraulic Fluid: Viscosity 35 mm<sup>2</sup>/s (164 SSU), Specific Gravity 0.850

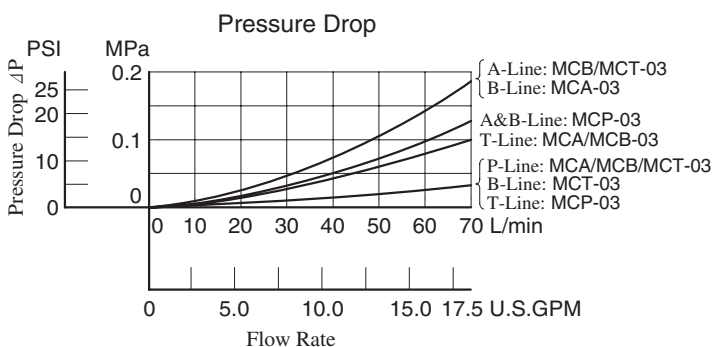
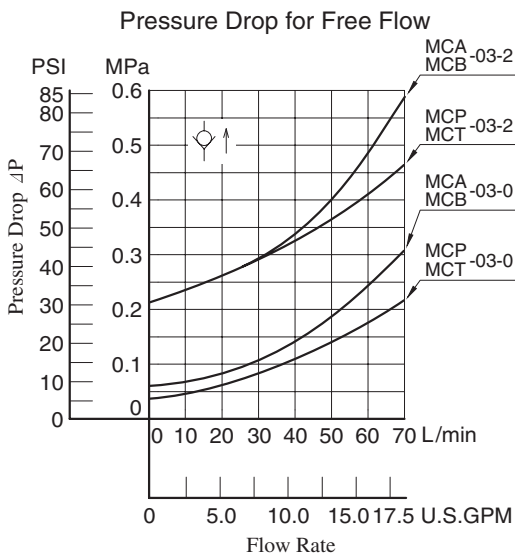

Model No.	Graphic Symbols	Detailed Graphic Symbols
MCP-03		
MCA-03		
MCB-03		
MCT-03		

### Instructions

#### ● Tank Line Used

Check valve function of MCT-03 is included in TA-Line. Therefore, the tank line for a circuit that uses this valve must be TA-line.

### MCP-03-\*-10

Approx. Mass.....2.5 kg (5.5 lbs.)

### MCA-03-\*-20 MCB-03-\*-20

Approx. Mass.....3.5 kg (7.7 lbs.)

### MCT-03-\*-10

(Check valve is included)

Approx. Mass.....2.8 kg (6.2 lbs.)

**DIMENSIONS IN MILLIMETRES (INCHES)**

**■ Spare Parts List**

#### MCP-03-\*-10

**● List of Seals**

Item	Name of Parts	Part Numbers	Qty.	Remarks
8	O-Ring	SO-NB-A014	5	Included in Seal Kit Kit No.: KS-MCP-03-10
9	O-Ring	SO-NB-P21	1	

#### MCT-03-\*-10

**● List of Seals**

Item	Name of Parts	Part Numbers	Qty.	Remarks
7	O-Ring	SO-NB-A014	5	Included in Seal Kit Kit No.: KS-MCP-03-10
8	O-Ring	SO-NB-P21	1	

#### MCA-03-\*-20

**● List of Seals**

Item	Name of Parts	Part Numbers	Qty.	Remarks
6	O-Ring	SO-NB-A014	5	Included in Seal Kit Kit No.: KS-MCA-03-20
7	O-Ring	SO-NB-P24	2	

#### MCB-03-\*-20

## Check Modular Valves For "P&T" Lines

### Specifications

Model Numbers	Max. Operating Pressure MPa (PSI)	Max. Flow L/min (U.S.GPM)
MCPT-03-P*-T*-10	25 (3630)	70 (18.5)

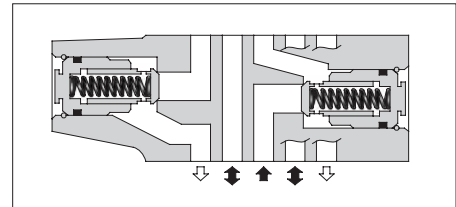
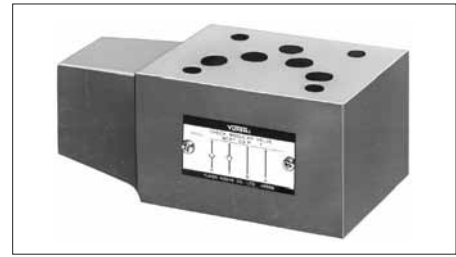

### Model Number Designation

F-	MCPT	-03	-P0	-T0	-10	*
Special Seals	Series Number	Valve Size	Cracking Pres. of P-Line MPa(PSI)	Cracking Pres. of T-Line MPa(PSI)	Design Number	Design Standard
<b>F</b> : Special Seals for Phosphate Ester Type Fluids (Omit if not required)	<b>MCPT</b> : Check Valve for P&T-Lines	<b>03</b>	<b>P0</b> : 0.035(5) <b>P2</b> : 0.2(29)	<b>T0</b> : 0.035(5) <b>T2</b> : 0.2(29)	<b>10</b>	Refer to ★

★ Design Standards: None ..... Japanese Standard "JIS", European Design Standard and N. American Design Standard

### Typical Performance Characteristics

Hydraulic Fluid: Viscosity 35 mm<sup>2</sup>/s (164 SSU), Specific Gravity 0.850

Pressure Drop for Free Flow

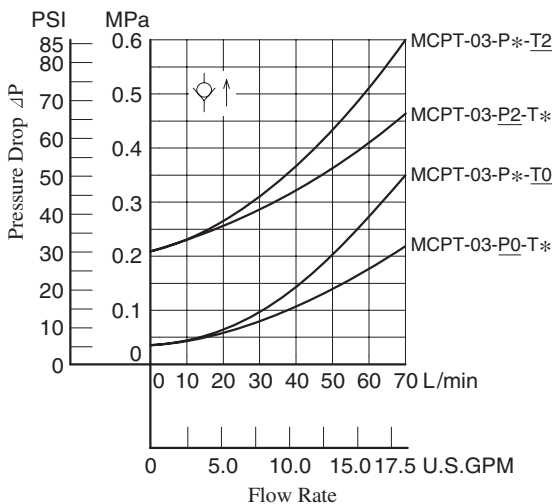

Pressure Drop

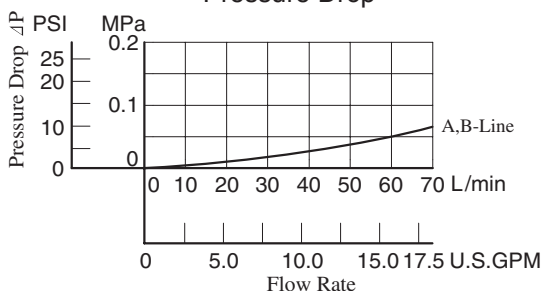

Graphic Symbol

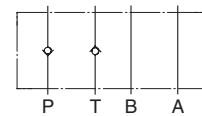

Detailed Graphic Symbol

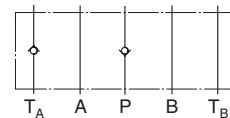

### Instructions

#### ● Tank Line Used

Check valve function of Tank Line is included in TA-Line. Therefore, the tank line for a circuit that uses this valve must be TA-line.

**MCPT-03-P\*-T\*-10**

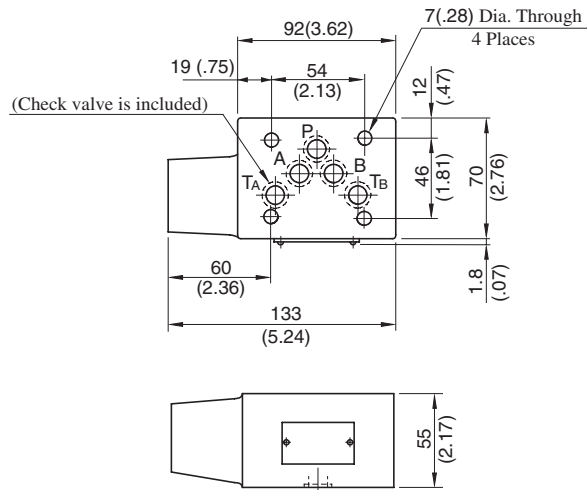

Approx. Mass.....2.7 kg (6.0 lbs.)

**DIMENSIONS IN  
MILLIMETRES (INCHES)**

**■ Spare Parts List**

**MCPT-03-P\*-T\*-10**

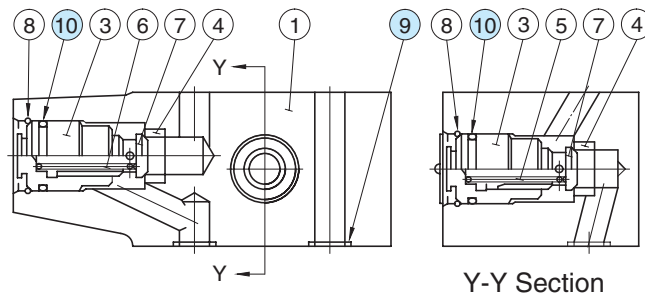

**● List of Seals**

Item	Name of Parts	Part Numbers	Qty.	Remarks
9	O-Ring	SO-NB-A014	5	Included in Seal Kit
10	O-Ring	SO-NB-P21	2	Kit No.: KS-MCPT-03-10



## Anti-Cavitation Modular Valves

### Specifications

Model Number	Max. Operating Pressure MPa (PSI)	Max. Flow L/min (U.S.GPM)
MAC-03-10	25 (3630)	70 (18.5)

### Model Number Designation

F-	MAC	-03	-10	*
Special Seals	Series Number	Valve Size	Design Number	Design Standard
<b>F:</b> Special Seals for Phosphate Ester Type Fluids (Omit if not required)	<b>MAC:</b> Anti-Cavitation Valve	<b>03</b>	<b>10</b>	Refer to ★

★ Design Standards: None ..... Japanese Standard "JIS", European Design Standard and N. American Design Standard

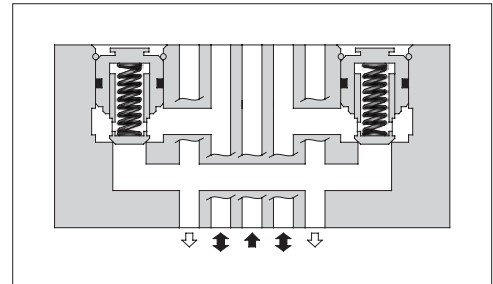

### Pressure Drop

Hydraulic Fluid: Viscosity 35 mm<sup>2</sup>/s (164 SSU), Specific Gravity 0.850

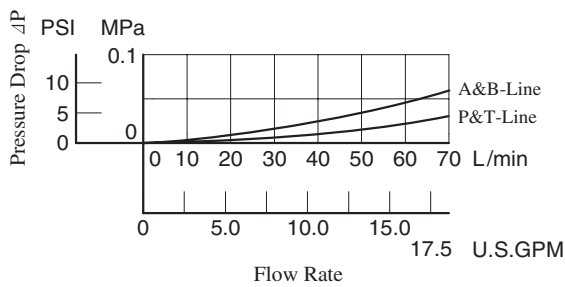

### Graphic Symbol

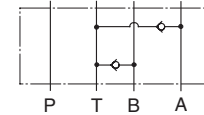

### Detailed Graphic Symbol

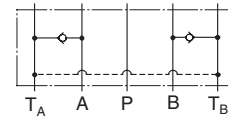

### MAC-03-10

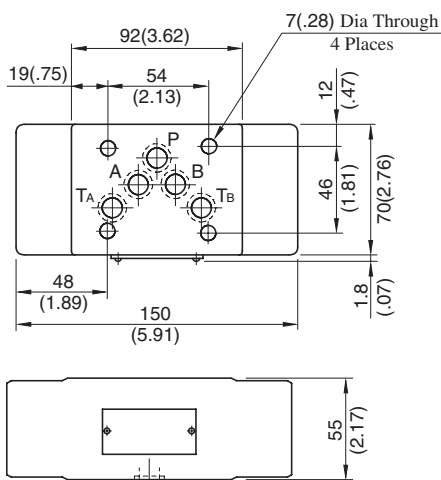

Approx. Mass.....3.8 kg (8.4 lbs.)

**DIMENSIONS IN  
MILLIMETRES (INCHES)**

### Spare Parts List

#### MAC-03-10

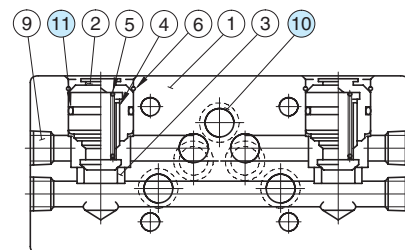

#### List of Seals

Item	Name of Parts	Part Numbers	Qty.	Remarks
10	O-Ring	SO-NB-A014	5	Included in Seal Kit
11	O-Ring	SO-NB-P21	2	Kit No.: KS-MAC-03-10

## Pilot Operated Check Modular Valves

### Specifications

Model Numbers		Max. Operating Pressure MPa (PSI)	Max. Flow L/min (U.S.GPM)
Standard	MP*-03-*-20	25 (3630)	70 (18.5)
Low Pilot Pressure Control Type	MP*-03-*-2001		

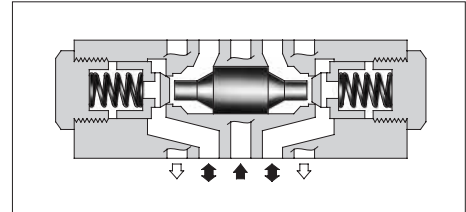

### Model Number Designation

F-	MPA	-03	-2	-20	*
Special Seals	Series Number	Valve Size	Cracking Pressure MPa (PSI)	Design Number	Design Standard
<b>F:</b> Special Seals for Phosphate Ester Type Fluids (Omit if not required)	<b>MPA :</b> Pilot Operated Check Valve for A-Line <b>MPB :</b> Pilot Operated Check Valve for B-Line <b>MPW :</b> Pilot Operated Check Valve for A&B-Lines	<b>03</b>	<b>2 :</b> 0.2 (29) <b>4 :</b> 0.4 (58)	<b>20</b> (Standard) <b>2001</b> (Low Pilot Pressure Control Type)	Refer to ★

★ Design Standards: None ..... Japanese Standard "JIS", European Design Standard and N. American Design Standard

Model No.	Graphic Symbols	Detailed Graphic Symbols
MPA-03		
MPB-03		
MPW-03		

## Typical Performance Characteristics

Hydraulic Fluid: Viscosity 35 mm<sup>2</sup>/s (164 SSU), Specific Gravity 0.850

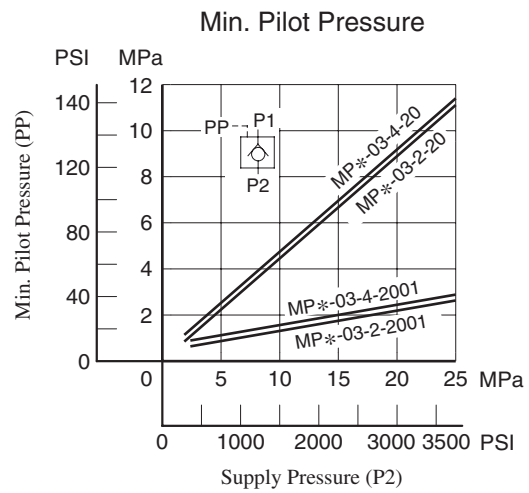
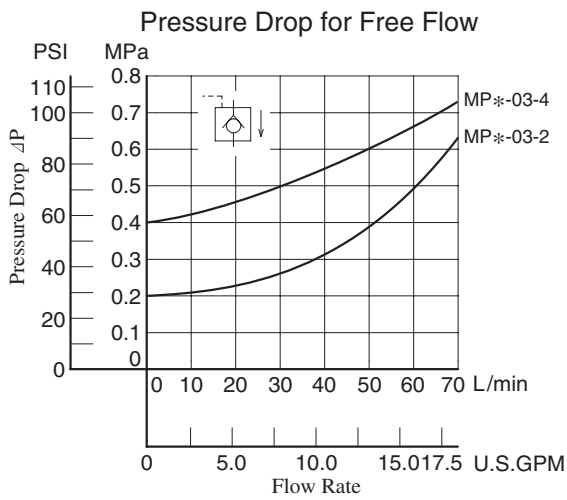
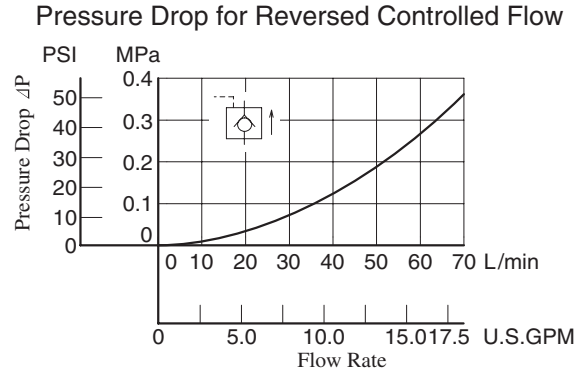
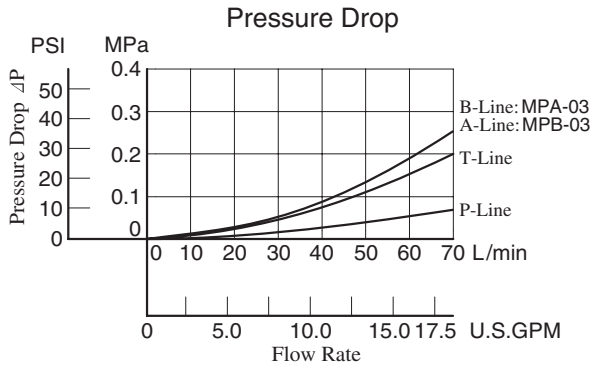

MPA-03-\*-20/2001  
 MPB-03-\*-20/2001  
 MPW-03-\*-20/2001

**DIMENSIONS IN  
 MILLIMETRES (INCHES)**

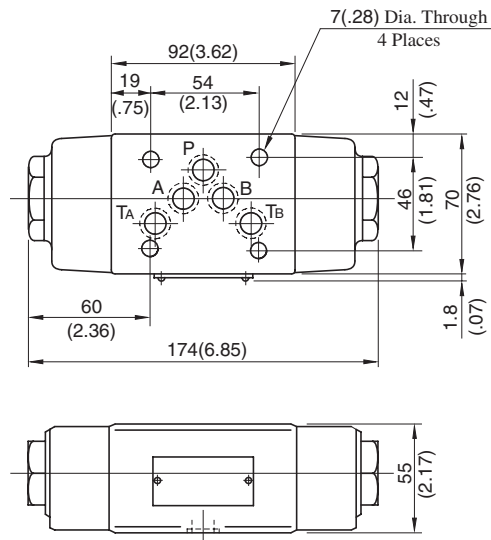

Approx. Mass..... 3.5 kg (7.7 lbs.)

■ Spare Parts List

MPA-03-\*-20

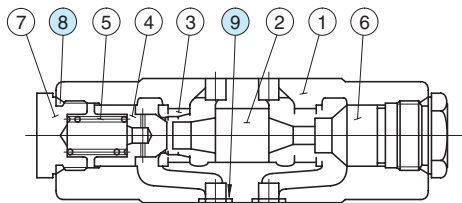

MPB-03-\*-20

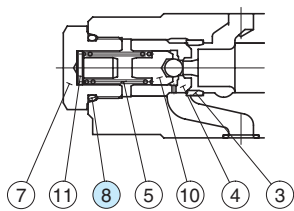
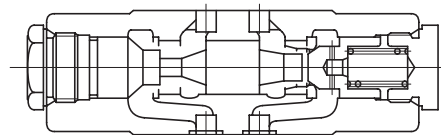

Low Pilot Pressure Control Type  
 (MPA-03-\*-2001)

● List of Seals

Item	Name of Parts	Part Numbers	Qty.	Remarks
8	O-Ring	SO-NB-P24	2	Included in Seal Kit
9	O-Ring	SO-NB-A014	5	Kit No.: KS-MPA-03-20

MPW-03-\*-20

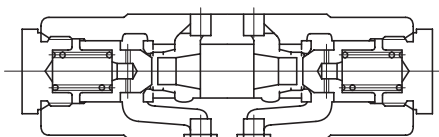

## End Plates

Blocking plates are used for auxiliary mounting surfaces or for closing unnecessary circuit.

Bypass plates are used for one-way flow circuit that requires no solenoid operated directional valves.



## Specifications

Model Numbers	Max. Operating Pressure MPa (PSI)	Max. Flow L/min (U.S.GPM)
MDC-03-*-10	25 (3630)	70 (18.5)

## Model Number Designation

F-	MDC	-03	-A	-10	*
Special Seals	Series Number	Valve Size	Type of Plate	Design Number	Design Standard
<b>F:</b> Special Seals for Phosphate Ester Type Fluids (Omit if not required)	<b>MDC:</b> End Plate	<b>03</b>	<b>A:</b> Blocking Plate <b>B:</b> Bypass Plate	<b>10</b>	<b>None:</b> Japanese Standard "JIS", European Design Standard and N. American Design Standard

## Pressure Drop

Hydraulic Fluid: Viscosity 35 mm<sup>2</sup>/s (164 SSU), Specific Gravity 0.850

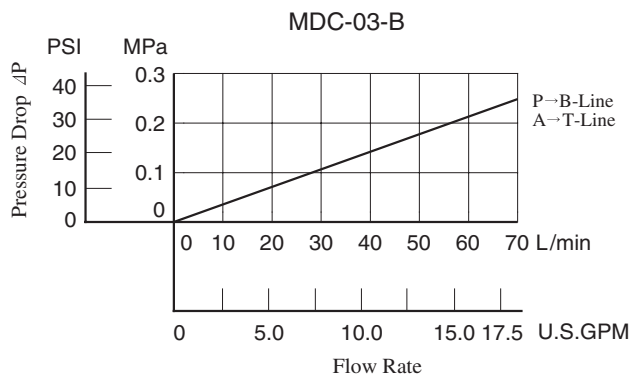

Model No.	Graphic Symbols	Detailed Graphic Symbols
MDC-03-A		
MDC-03-B		

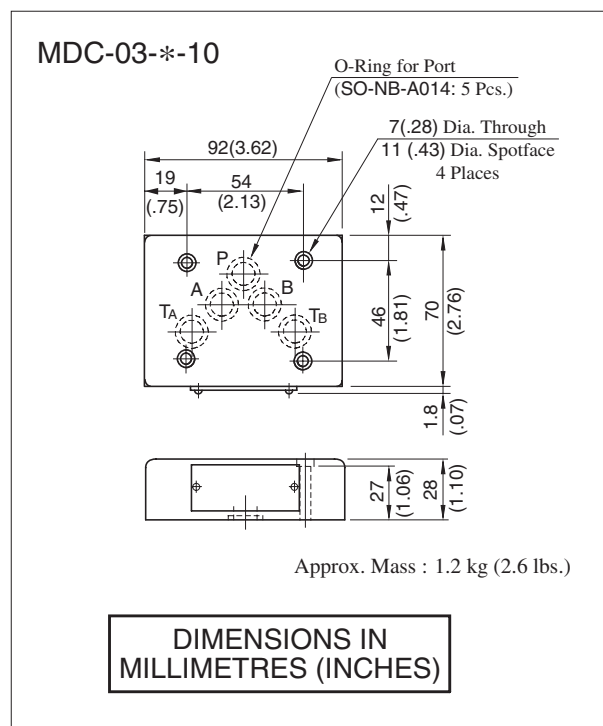

## Connecting Plates

### Specifications

Model Numbers	Max. Operating Pressure MPa (PSI)	Max. Flow L/min (U.S.GPM)
MDS-03-10/1090	25 (3630)	70 (18.5)



### Model Number Designation

F-	MDS	-03	-10	*
Special Seals	Series Number	Valve Size	Design Number	Design Standard
<b>F:</b> Special Seals for Phosphate Ester Type Fluids (Omit if not required)	<b>MDS:</b> Connecting Plate	<b>03</b>	<b>10</b>	<b>None:</b> Japanese Standard "JIS" and European design Standard <b>90:</b> N.American Design Standard

### Pressure Drop

Hydraulic Fluid: Viscosity 35 mm<sup>2</sup>/s (164 SSU), Specific Gravity 0.850

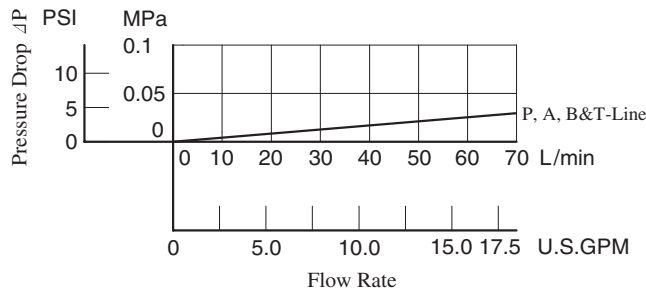

### Graphic Symbol

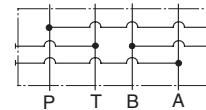

### Detailed Graphic Symbol

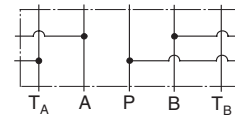

### MDS-03-10/1090

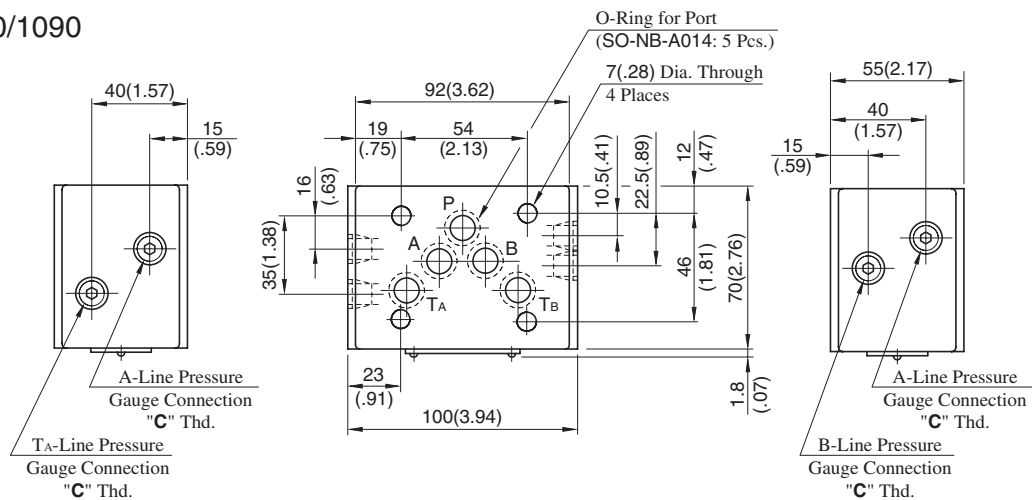

Approx. Mass.....2.5 kg (5.5 lbs.)

Model Numbers	Thread Size "C" Thd.
MDS-03-10	Rc 1/4 = 1/4 BSP.Tr
MDS-03-1090	1/4 NPT

**DIMENSIONS IN  
MILLIMETRES (INCHES)**

## Base Plates For Modular Valves

### Specifications

Max. Operating Pressure ----- 25 MPa (3630 PSI)

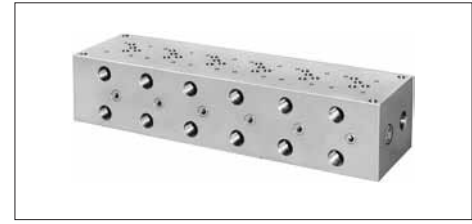

### Model Number Designation

MMC	-03	-T	-6	-21	*
Series Number	Plate Size	Type of Connection	Number of Stations	Design Number	Design Standard
MMC : Base Plate	03	T : Threaded Connection	1: 1 Station 2: 2 Stations 3: 3 Stations 4: 4 Stations	5: 5 Stations 6: 6 Stations 7: 7 Stations 21	None: Japanese Standard "JIS" 80: European Design Standard 90: N.American Design Standard

### Pressure Drop

Hydraulic Fluid: Viscosity 35 mm<sup>2</sup>/s (164 SSU), Specific Gravity 0.850

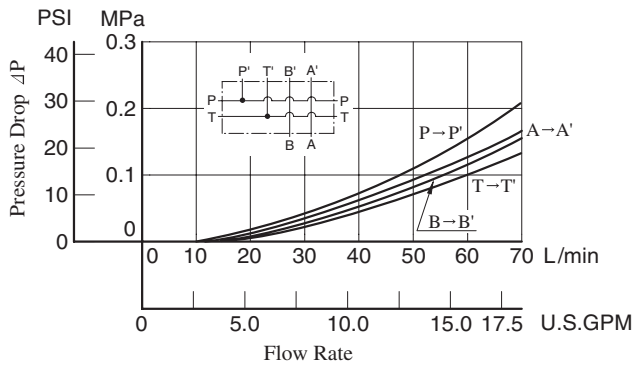

### Graphic Symbol

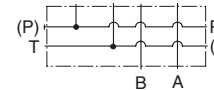

### Detailed Graphic Symbol

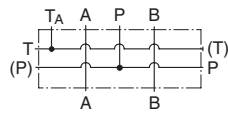

MMC-03-T-1

### Graphic Symbol

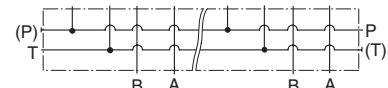

MMC-03-T-2-7

### Mounting Surface Dimensions for 3/8 Modular Valve

When the standard base plate (MMC-03) is not used, the following mounting surface must be prepared. Also, the mounting surface must have a good machined finish.

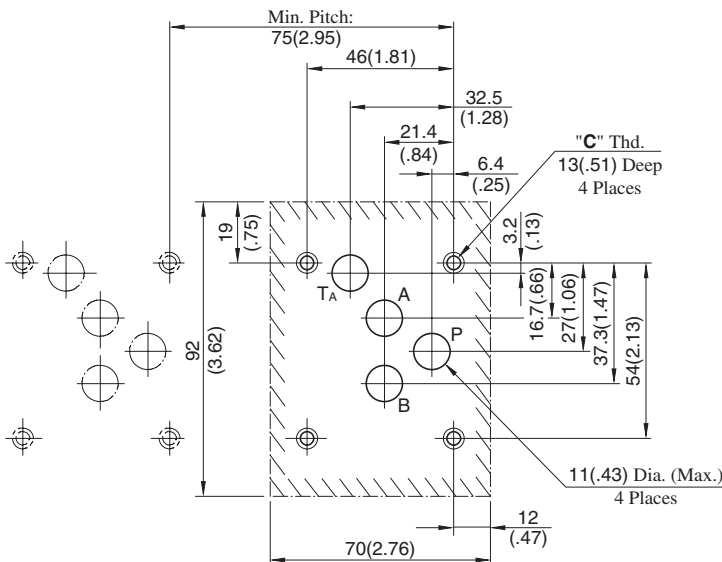

DIMENSIONS IN MILLIMETRES (INCHES)

Design Std.	"C" Thd.
Japanese Standard "JIS" and European Design Standard	M6
N.American Design Standard	1/4-20 UNC

### Instructions

- Although two ports are provided for both pressure port "P" and tank port "T", either may be used.

However, the ports having (P) or (T) in the drawing are normally plugged. Remove the plugs of the ports when they are used. Make sure that the ports that are not currently used are properly plugged.

**MMC-03-T-1-21/2190**

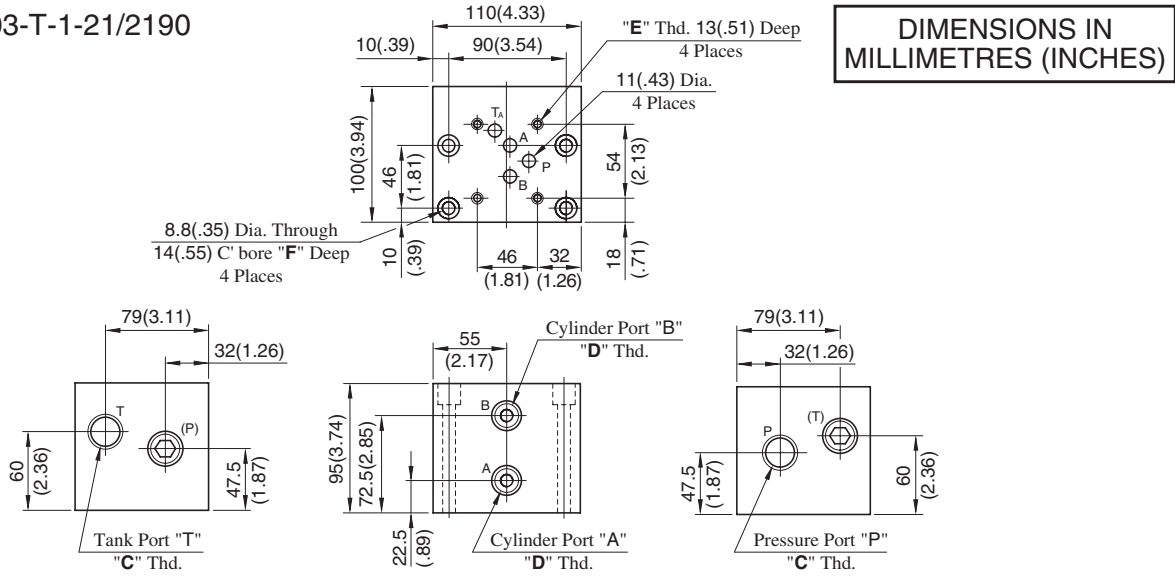

**MMC-03-T-\*21/2190**

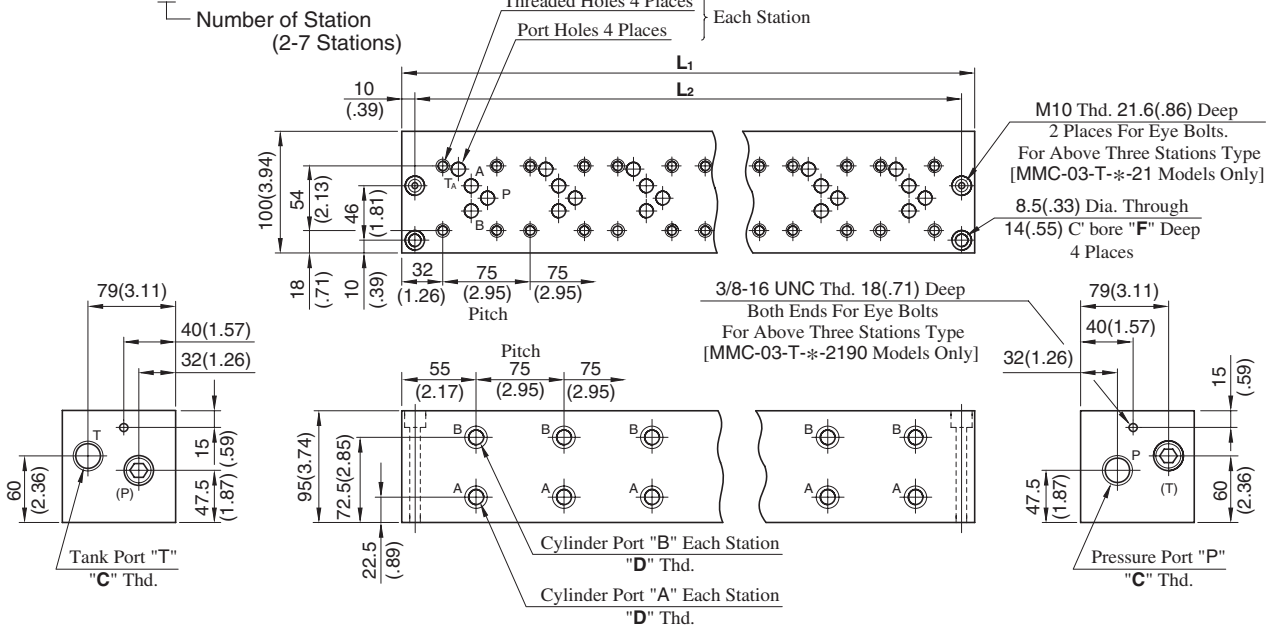

• For other dimensions, refer to above Model MMC-03-T-1.

Model Numbers	Thread Size			Dimensions mm (Inches)			Approx. Mass kg (lbs.)
	"C" Thd.	"D" Thd.	"E" Thd.	F	L1	L2	
MMC-03-T-1-21	Rc 3/4	Rc 1/2	M6	8.6 (.34)	—	—	8.5 (18.7)
MMC-03-T-1-2190	3/4 NPT	1/2 NPT	1/4-20 UNC	22 (.87)	—	—	
MMC-03-T-2-21	Rc 3/4	Rc 1/2	M6	8.6 (.34)	185	165	14 (30.9)
MMC-03-T-2-2190	3/4 NPT	1/2 NPT	1/4-20 UNC	22 (.87)	(7.28)	(6.50)	
MMC-03-T-3-21	Rc 3/4	Rc 1/2	M6	8.6 (.34)	260	240	19.5 (43.0)
MMC-03-T-3-2190	3/4 NPT	1/2 NPT	1/4-20 UNC	22 (.87)	(10.24)	(9.45)	
MMC-03-T-4-21	Rc 3/4	Rc 1/2	M6	8.6 (.34)	335	315	25 (55.1)
MMC-03-T-4-2190	3/4 NPT	1/2 NPT	1/4-20 UNC	22 (.87)	(13.19)	(12.40)	
MMC-03-T-5-21	Rc 3/4	Rc 1/2	M6	8.6 (.34)	410	390	30.5 (67.3)
MMC-03-T-5-2190	3/4 NPT	1/2 NPT	1/4-20 UNC	22 (.87)	(16.14)	(15.35)	
MMC-03-T-6-21	Rc 3/4	Rc 1/2	M6	8.6 (.34)	485	465	36 (79.4)
MMC-03-T-6-2190	3/4 NPT	1/2 NPT	1/4-20 UNC	22 (.87)	(19.09)	(18.31)	
MMC-03-T-7-21	Rc 3/4	Rc 1/2	M6	8.6 (.34)	560	540	41 (90.4)
MMC-03-T-7-2190	3/4 NPT	1/2 NPT	1/4-20 UNC	22 (.87)	(22.05)	(21.26)	



## MMC-03-T-1-2180

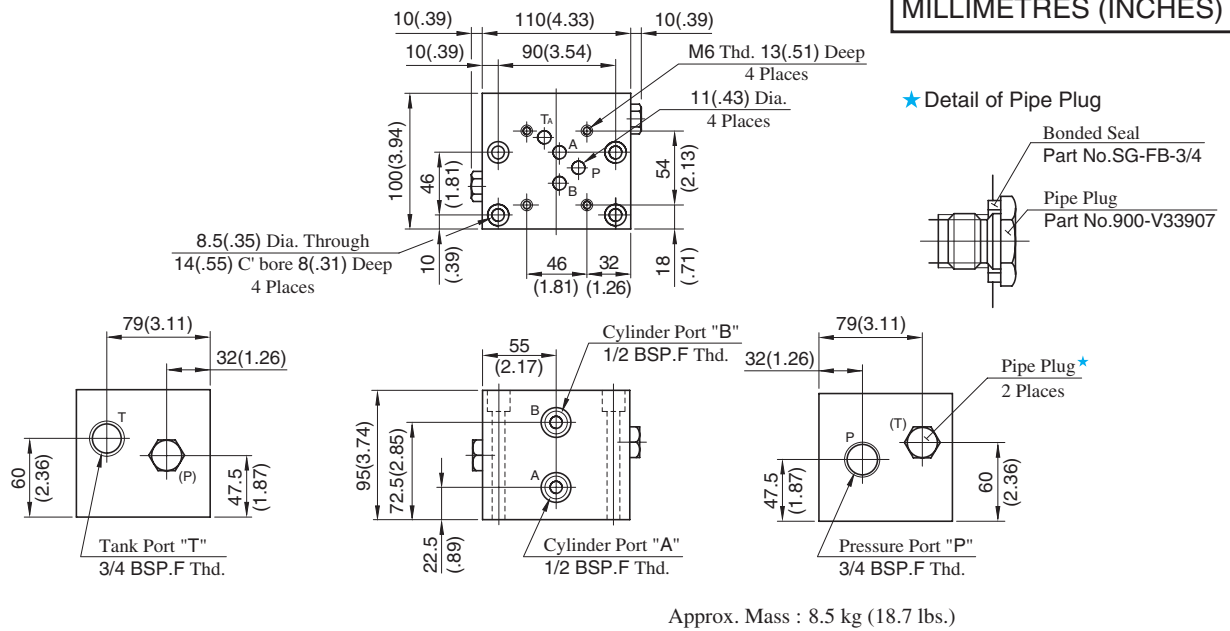

## MMC-03-T-\*2180

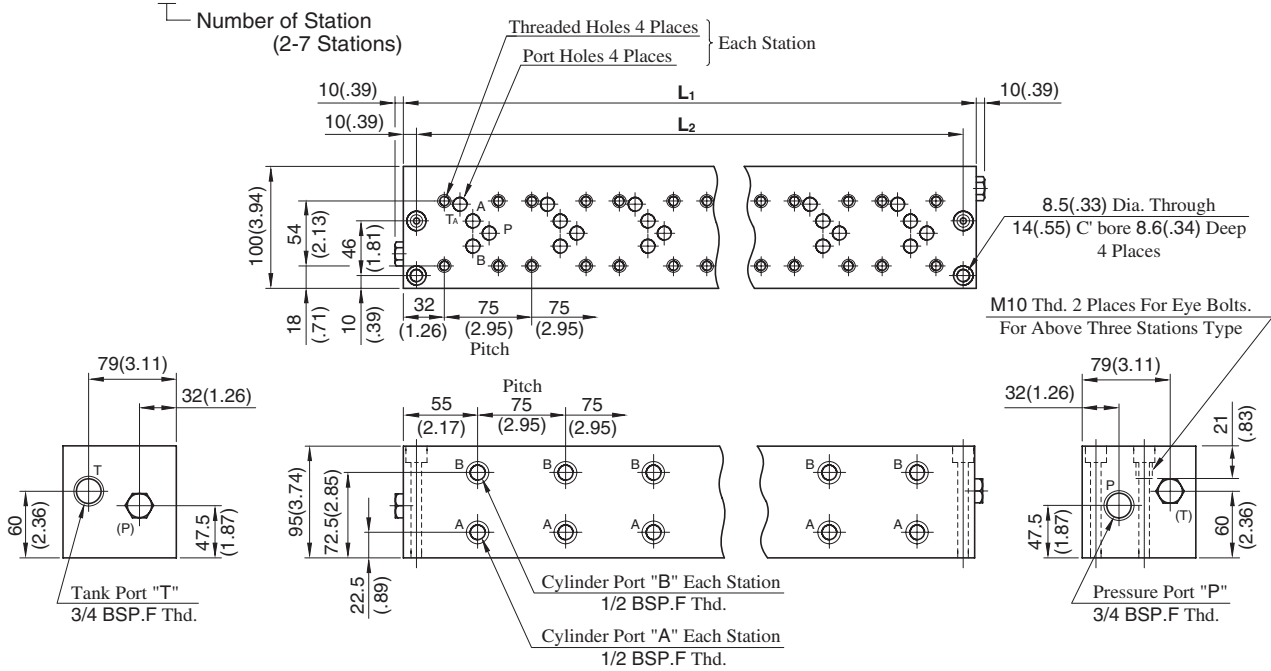

• For other dimensions, refer to above Model MMC-03-T-1.

Model Numbers	Dimensions mm (Inches)		Approx. Mass kg (lbs.)
	L <sub>1</sub>	L <sub>2</sub>	
MMC-03-T-2-2180	185 (7.28)	165 (6.50)	14 (30.9)
MMC-03-T-3-2180	260 (10.24)	240 (9.45)	19.5 (43.0)
MMC-03-T-4-2180	335 (13.19)	315 (12.40)	25 (55.1)
MMC-03-T-5-2180	410 (16.14)	390 (15.35)	30.5 (67.3)
MMC-03-T-6-2180	485 (19.09)	465 (18.31)	36 (79.4)
MMC-03-T-7-2180	560 (22.05)	540 (21.26)	41 (90.4)

## Mounting Bolt Kits For Modular Valves

Valves are mounted with four stud bolts. Valve combination varies according to the circuit type. Hence, the mounting bolt kits are available on a combination type basis. When ordering the mounting bolt kit, be sure to give the bolt kit model number from the table below.



### Model Number Designation

MBK	-03	-04	-10	*
Series Number	Size of Modular Valve	Bolt Number	Design Number	Design Standard
MBK: Mounting Bolt Kits for Modular Valve	03	01, 02, 03, 04, 05 (Refer to the following chart)	10	Refer to ★

★ Design Standards: None ..... Japanese Standard "JIS" and European Design Standard 90 ..... N. American Design Standard

### Bolt Kit Composition

Stud Bolt ----- 4 Pcs. } 1 Set  
Nut ----- 4 Pcs. }

Note: In case of bolt kit model number having "05", four hexagon socket head cap screws only.

### Tightening Torque:

12-15 Nm (106-133 IN. lbs.)

### Bolt Kits Selection Chart

Model Numbers	Quantity of valves to be stacked			Approx. Mass g (lbs.)
	Solenoid Operated Directional Valve (*-DSG-03)	End Plate (MDC-03)	Modular Valve & Connecting Plate	
MBK-03-01-10*	1	0	1	120(.26)
	0	1		
MBK-03-02-10*	1	0	2	160(.35)
	0	1		
MBK-03-03-10*	1	0	3	200(.44)
	0	1		
MBK-03-04-10*	1	0	4	240(.53)
	0	1		
MBK-03-05-10*	1★	0	0	40(.09)
	0	1		

★ The solenoid operated directional valve comes with mounting bolts.

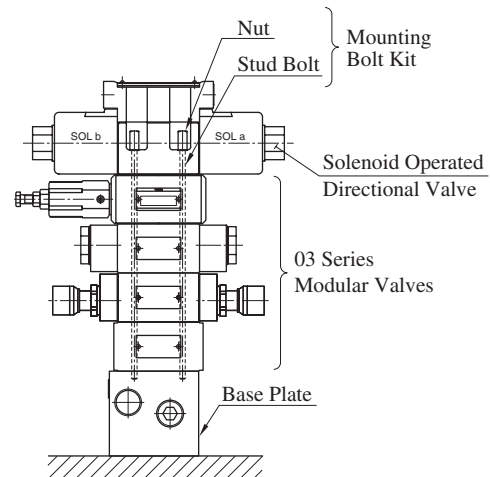

Stacking Example

### MBK-03-\*-10/1090

#### Stud Bolt

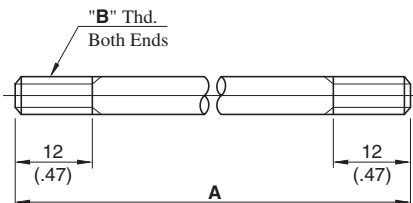

#### Nut

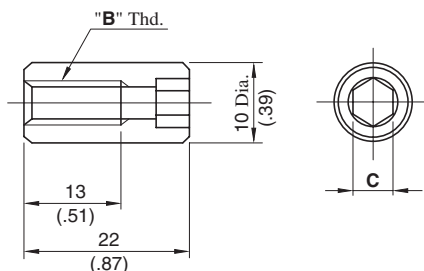

### MBK-03-05-10/1090

#### Socket Head Cap Screw

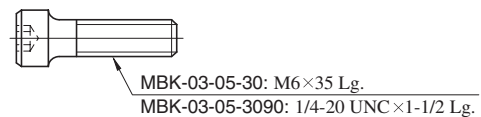

DIMENSIONS IN MILLIMETRES (INCHES)

Model Numbers	A mm (In.)	"B" Thd.	C
MBK-03-01-10	103 ( 4.06)	M6	5 (.20)
MBK-03-02-10	158 ( 6.22)		
MBK-03-03-10	213 ( 8.39)		
MBK-03-04-10	268 (10.55)		
MBK-03-01-1090	103 ( 4.06)	1/4-20 UNC	4.76 (3/16)
MBK-03-02-1090	158 ( 6.22)		
MBK-03-03-1090	213 ( 8.39)		
MBK-03-04-1090	268 (10.55)		